



3

9

Handwritten text in Italian: "Famò numero di
punti"

particolare A. 1/25

particolare B. 1/25



tabella degli angoli

1.	10	20	30	40
2.	15	30	45	60
3.	20	35	50	65
4.	25	40	55	70

1



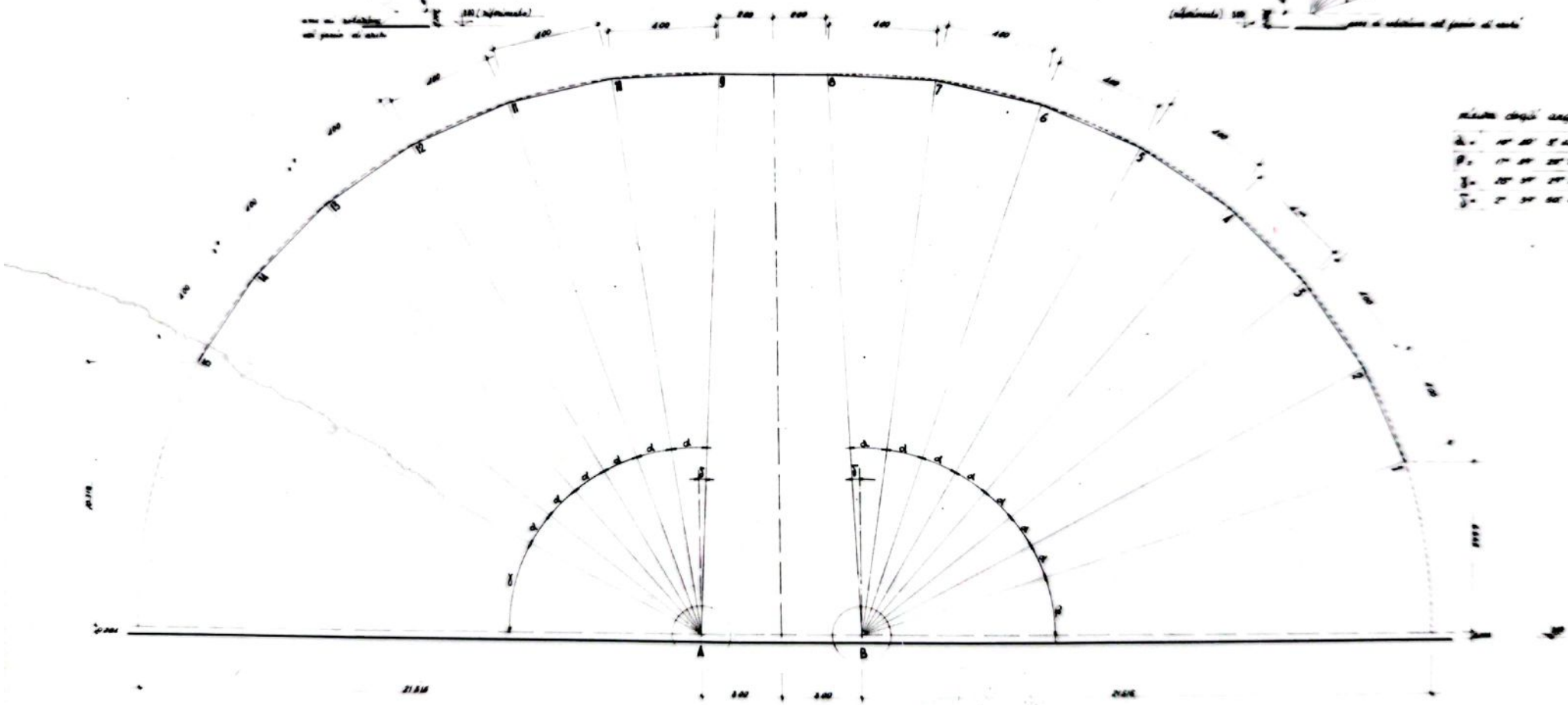
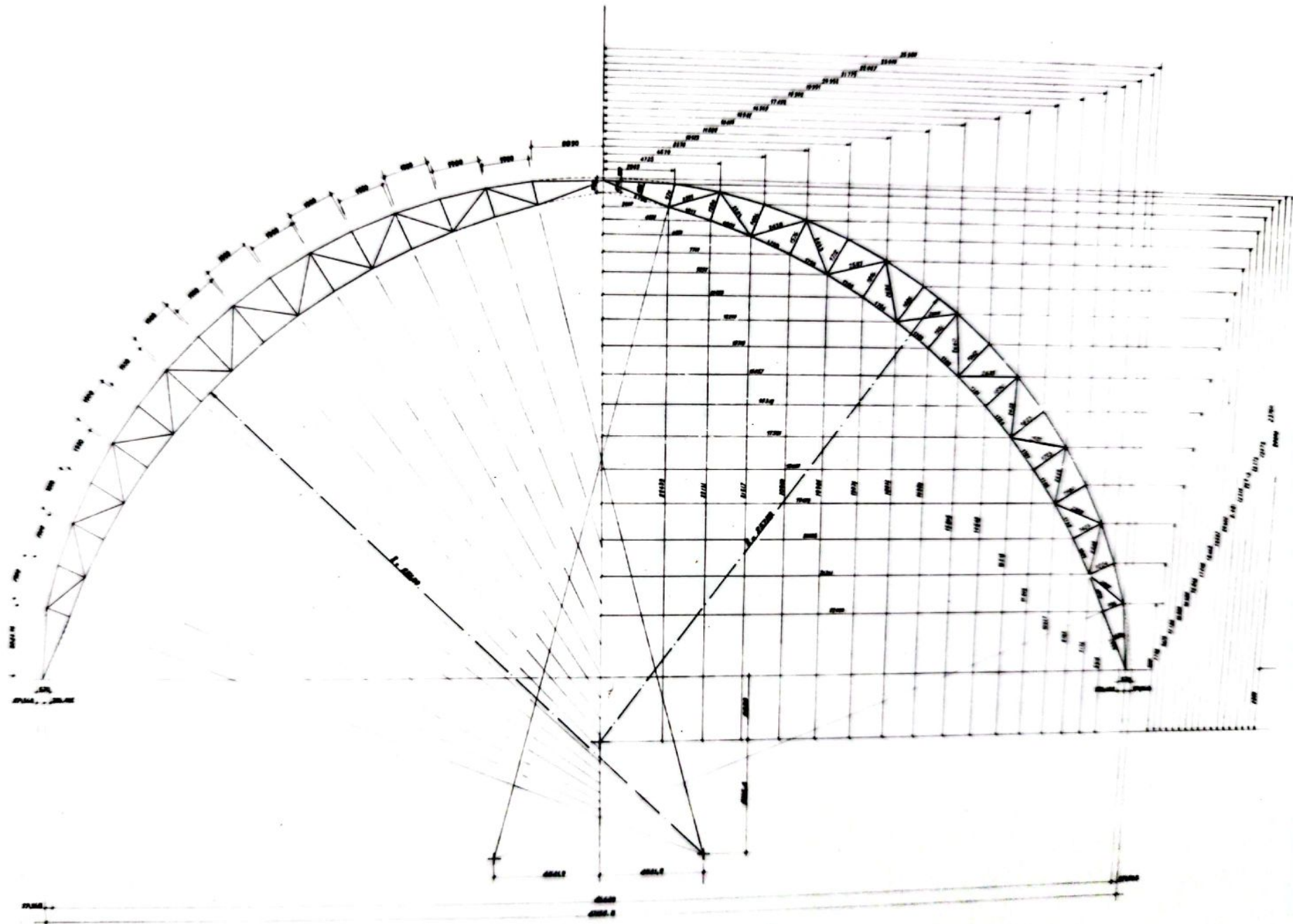

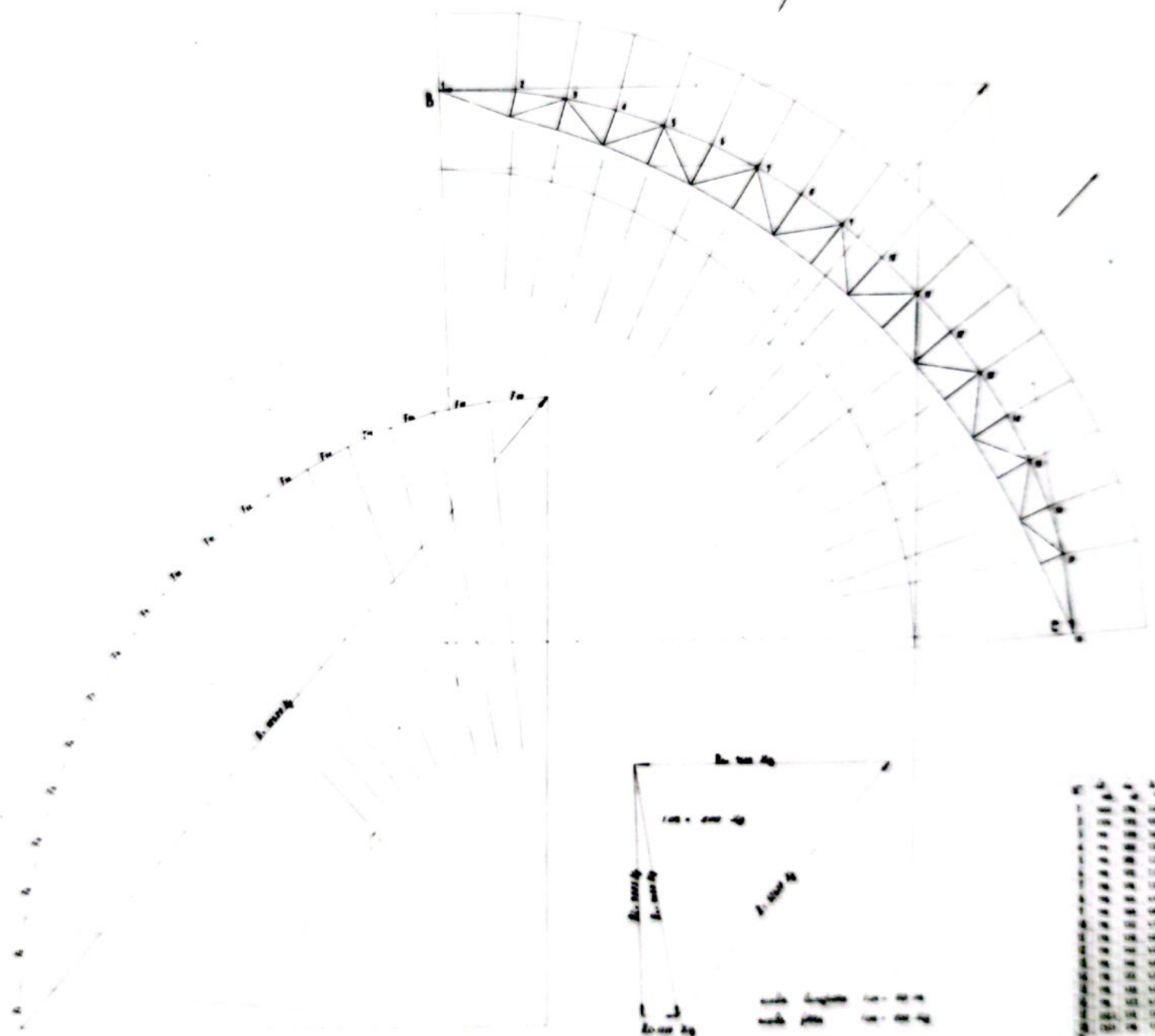

esempio di truss curva
del tipo

con dati: ...

1	2	3	4	5	6	7	8	9	10	11	12	13	14	15	16	17	18	19	20	21	22	23	24	25	26	27	28	29	30	31	32	33	34	35	36	37	38	39	40	41	42	43	44	45	46	47	48	49	50	51	52	53	54	55	56	57	58	59	60	61	62	63	64	65	66	67	68	69	70	71	72	73	74	75	76	77	78	79	80	81	82	83	84	85	86	87	88	89	90	91	92	93	94	95	96	97	98	99	100
---	---	---	---	---	---	---	---	---	----	----	----	----	----	----	----	----	----	----	----	----	----	----	----	----	----	----	----	----	----	----	----	----	----	----	----	----	----	----	----	----	----	----	----	----	----	----	----	----	----	----	----	----	----	----	----	----	----	----	----	----	----	----	----	----	----	----	----	----	----	----	----	----	----	----	----	----	----	----	----	----	----	----	----	----	----	----	----	----	----	----	----	----	----	----	----	----	----	----	-----

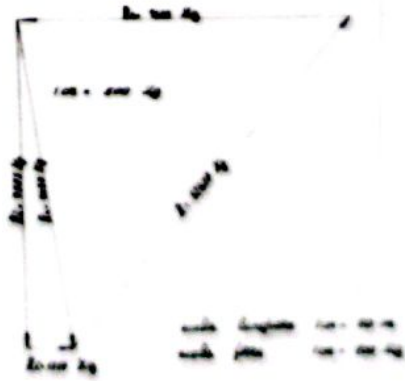

1	2	3	4	5	6	7	8	9	10	11	12	13	14	15	16	17	18	19	20	21	22	23	24	25	26	27	28	29	30	31	32	33	34	35	36	37	38	39	40	41	42	43	44	45	46	47	48	49	50	51	52	53	54	55	56	57	58	59	60	61	62	63	64	65	66	67	68	69	70	71	72	73	74	75	76	77	78	79	80	81	82	83	84	85	86	87	88	89	90	91	92	93	94	95	96	97	98	99	100
---	---	---	---	---	---	---	---	---	----	----	----	----	----	----	----	----	----	----	----	----	----	----	----	----	----	----	----	----	----	----	----	----	----	----	----	----	----	----	----	----	----	----	----	----	----	----	----	----	----	----	----	----	----	----	----	----	----	----	----	----	----	----	----	----	----	----	----	----	----	----	----	----	----	----	----	----	----	----	----	----	----	----	----	----	----	----	----	----	----	----	----	----	----	----	----	----	----	----	-----

esempio millimetrico simulato dal vento

scala lung. 1cm = 100cm

ν	l_x	l_y	h	τ	$\tau \cdot A$	C_{x-100}
	cm	cm	cm		cm ²	kg
1	1025	515	750	1.00	750	750
2	1015	490	700	0.95	700	700
3	1005	465	650	0.90	650	650
4	995	440	600	0.85	600	600
5	985	415	550	0.80	550	550
6	975	390	500	0.75	500	500
7	965	365	450	0.70	450	450
8	955	340	400	0.65	400	400
9	945	315	350	0.60	350	350
10	935	290	300	0.55	300	300
11	925	265	250	0.50	250	250
12	915	240	200	0.45	200	200
13	905	215	150	0.40	150	150
14	895	190	100	0.35	100	100
15	885	165	50	0.30	50	50
16	875	140	0	0.25	0	0
17	865	115	0	0.20	0	0
18	855	90	0	0.15	0	0
19	845	65	0	0.10	0	0
20	835	40	0	0.05	0	0
21	825	15	0	0.00	0	0
22	815	0	0	0.00	0	0
23	805	0	0	0.00	0	0
24	795	0	0	0.00	0	0
25	785	0	0	0.00	0	0
26	775	0	0	0.00	0	0
27	765	0	0	0.00	0	0
28	755	0	0	0.00	0	0
29	745	0	0	0.00	0	0
30	735	0	0	0.00	0	0
31	725	0	0	0.00	0	0
32	715	0	0	0.00	0	0
33	705	0	0	0.00	0	0
34	695	0	0	0.00	0	0
35	685	0	0	0.00	0	0
36	675	0	0	0.00	0	0
37	665	0	0	0.00	0	0
38	655	0	0	0.00	0	0
39	645	0	0	0.00	0	0
40	635	0	0	0.00	0	0
41	625	0	0	0.00	0	0
42	615	0	0	0.00	0	0
43	605	0	0	0.00	0	0
44	595	0	0	0.00	0	0
45	585	0	0	0.00	0	0
46	575	0	0	0.00	0	0
47	565	0	0	0.00	0	0
48	555	0	0	0.00	0	0
49	545	0	0	0.00	0	0
50	535	0	0	0.00	0	0
51	525	0	0	0.00	0	0
52	515	0	0	0.00	0	0
53	505	0	0	0.00	0	0
54	495	0	0	0.00	0	0
55	485	0	0	0.00	0	0
56	475	0	0	0.00	0	0
57	465	0	0	0.00	0	0
58	455	0	0	0.00	0	0
59	445	0	0	0.00	0	0
60	435	0	0	0.00	0	0
61	425	0	0	0.00	0	0
62	415	0	0	0.00	0	0
63	405	0	0	0.00	0	0
64	395	0	0	0.00	0	0
65	385	0	0	0.00	0	0
66	375	0	0	0.00	0	0
67	365	0	0	0.00	0	0
68	355	0	0	0.00	0	0
69	345	0	0	0.00	0	0
70	335	0	0	0.00	0	0
71	325	0	0	0.00	0	0
72	315	0	0	0.00	0	0
73	305	0	0	0.00	0	0
74	295	0	0	0.00	0	0
75	285	0	0	0.00	0	0
76	275	0	0	0.00	0	0
77	265	0	0	0.00	0	0
78	255	0	0	0.00	0	0
79	245	0	0	0.00	0	0
80	235	0	0	0.00	0	0
81	225	0	0	0.00	0	0
82	215	0	0	0.00	0	0
83	205	0	0	0.00	0	0
84	195	0	0	0.00	0	0
85	185	0	0	0.00	0	0
86	175	0	0	0.00	0	0
87	165	0	0	0.00	0	0
88	155	0	0	0.00	0	0
89	145	0	0	0.00	0	0
90	135	0	0	0.00	0	0
91	125	0	0	0.00	0	0
92	115	0	0	0.00	0	0
93	105	0	0	0.00	0	0
94	95	0	0	0.00	0	0
95	85	0	0	0.00	0	0
96	75	0	0	0.00	0	0
97	65	0	0	0.00	0	0
98	55	0	0	0.00	0	0
99	45	0	0	0.00	0	0
100	35	0	0	0.00	0	0
101	25	0	0	0.00	0	0
102	15	0	0	0.00	0	0
103	5	0	0	0.00	0	0
104	0	0	0	0.00	0	0

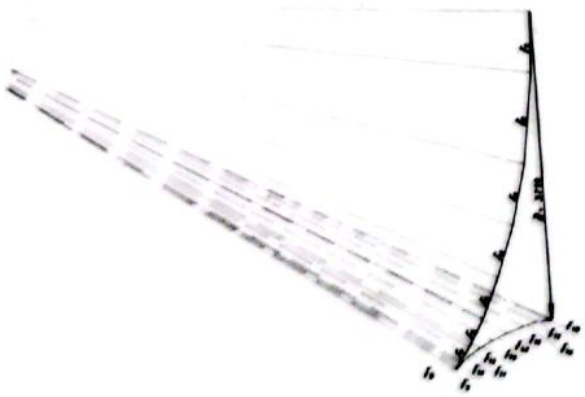
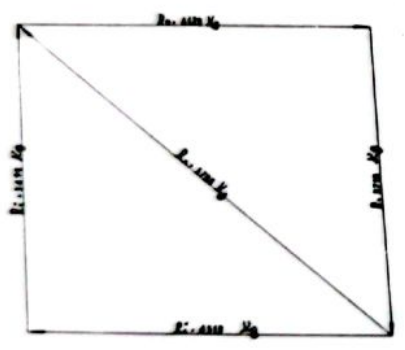
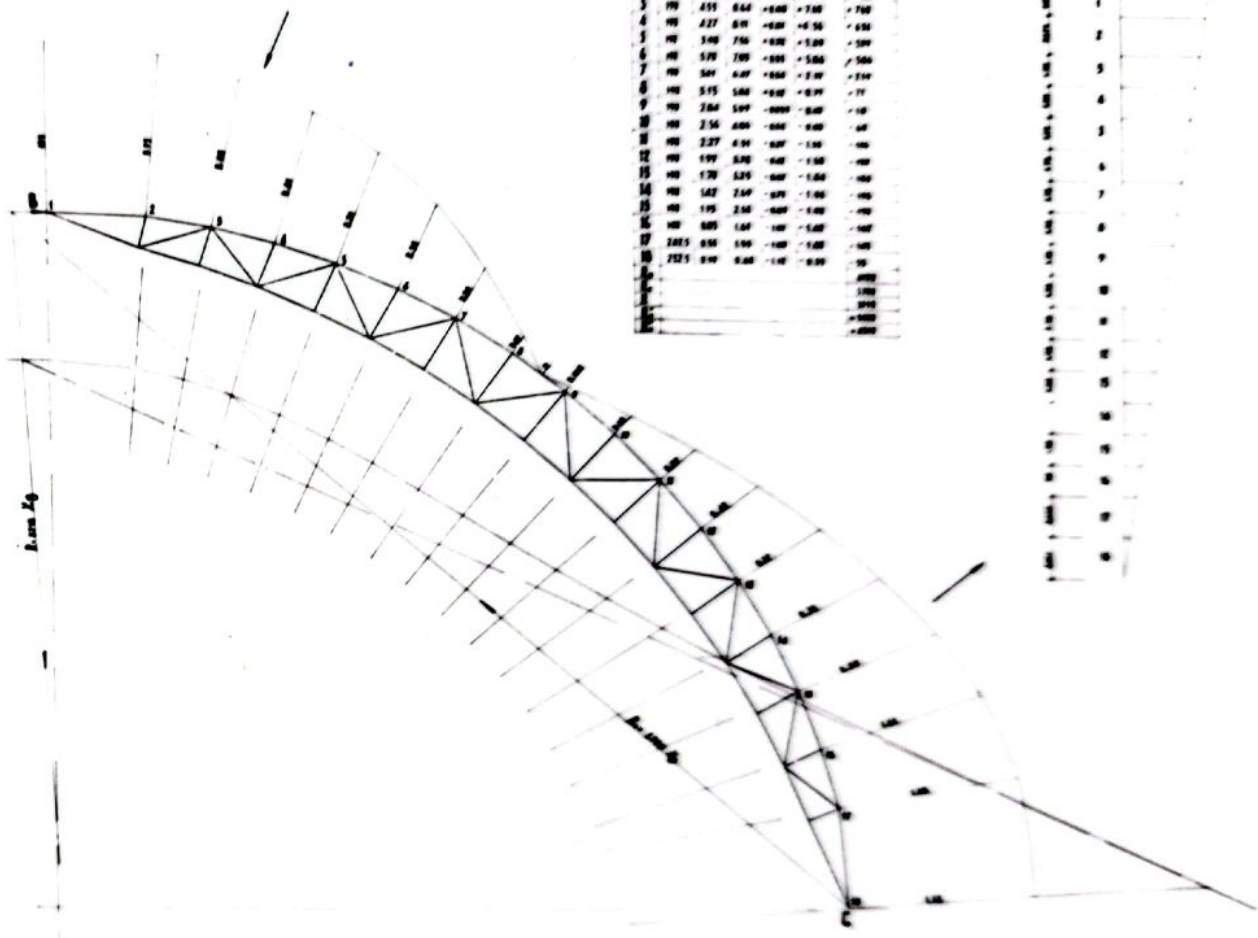
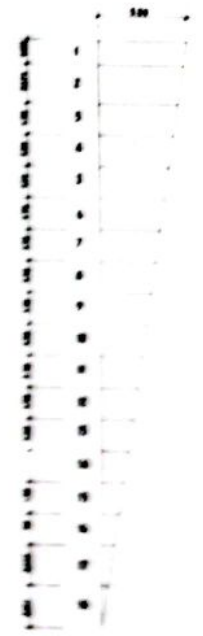

scala longitudinale: 1cm = 100cm
 scala trasversale: 1cm = 200cm

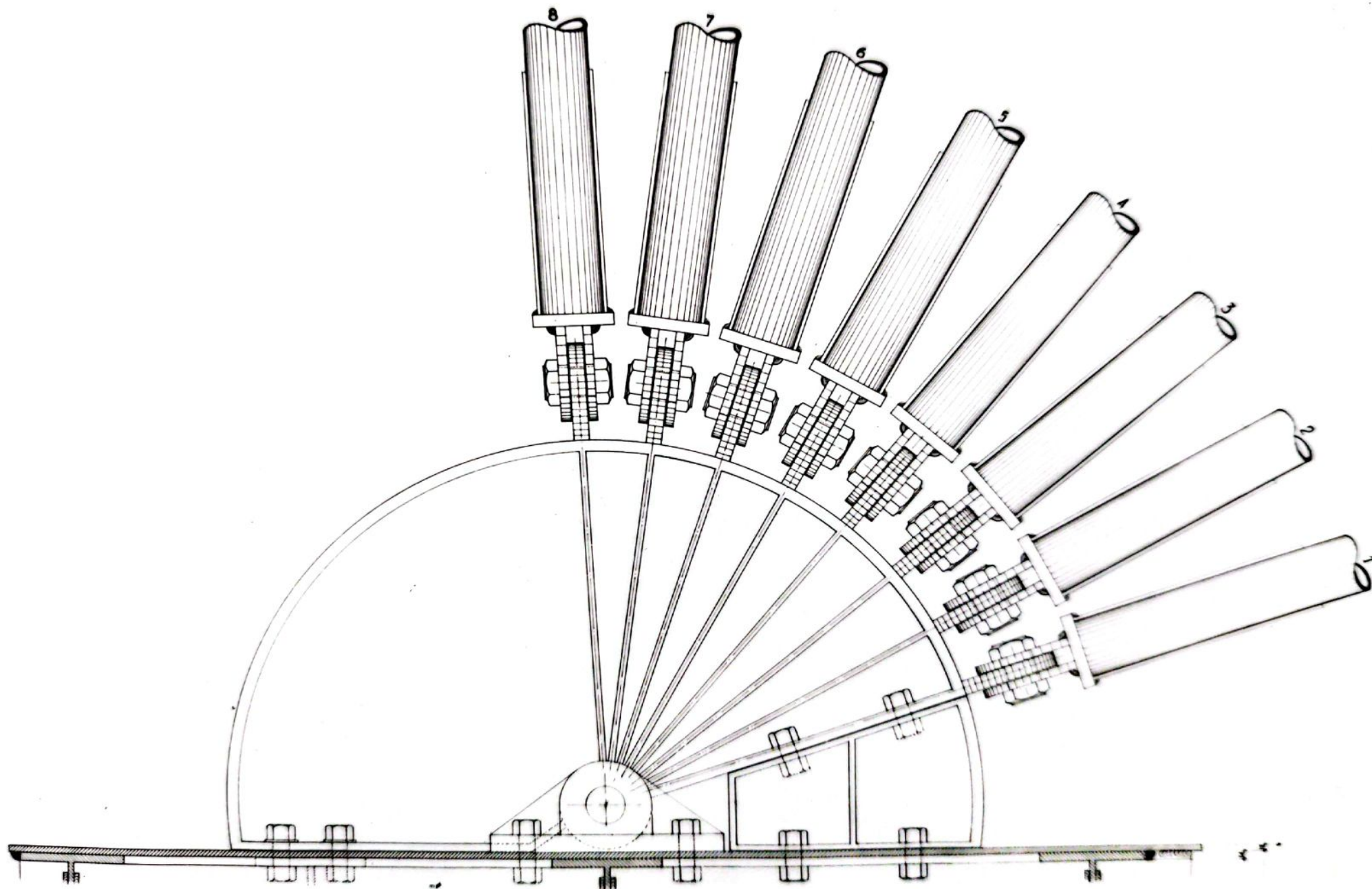

Alcova con divan letto (non serve)

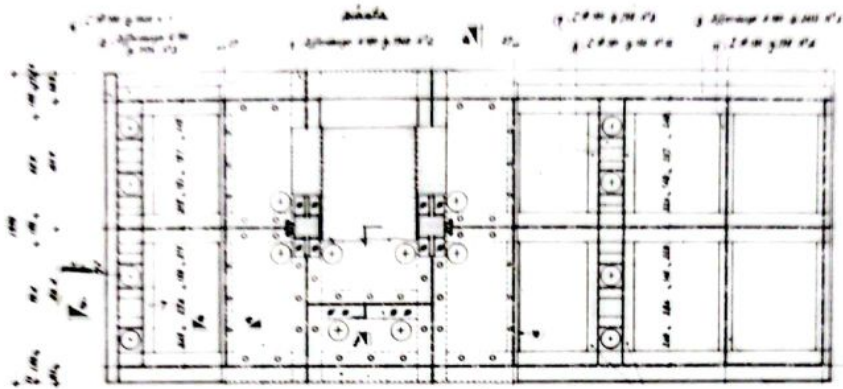

Apparecchio d'angolo
Inv. no. 17 24067

placche della lamina superiore (sp. 10 mm)

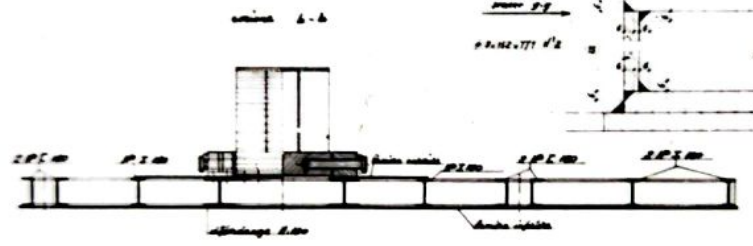
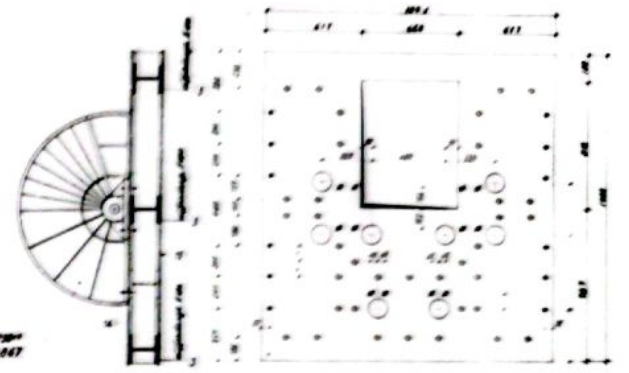

placche del piedistallo E. 12
per il supporto d'angolo di ferro

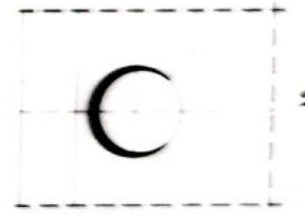

Se il divan letto serve, togli il divan letto per
mettere il letto in E. 12
Se il divan letto serve, togli il divan letto e mettilo
in E. 12

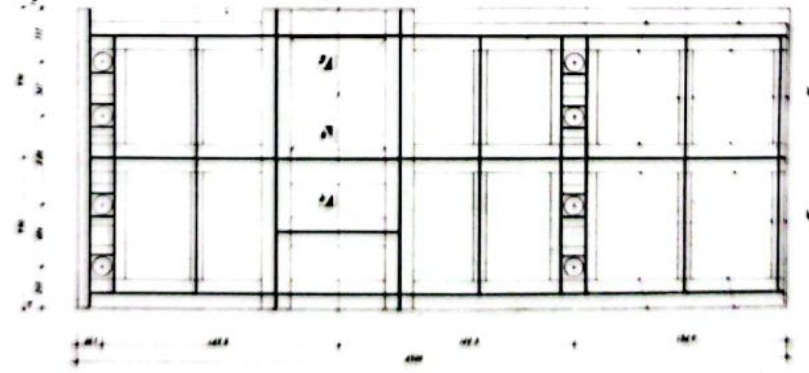
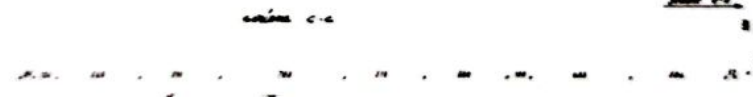

misura in centimetri

sezione b-b

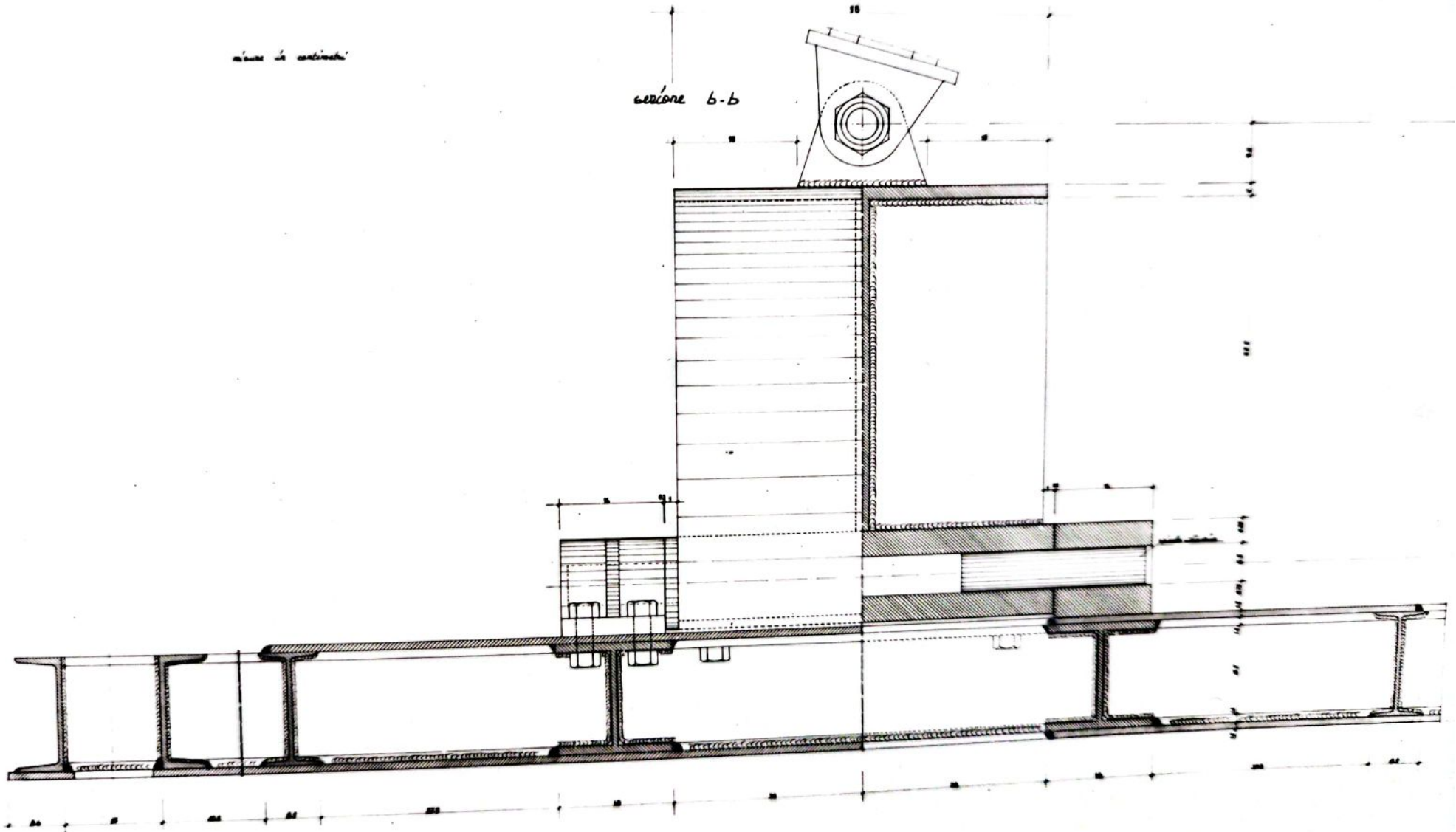

sezione in verticale

sezione 1.1

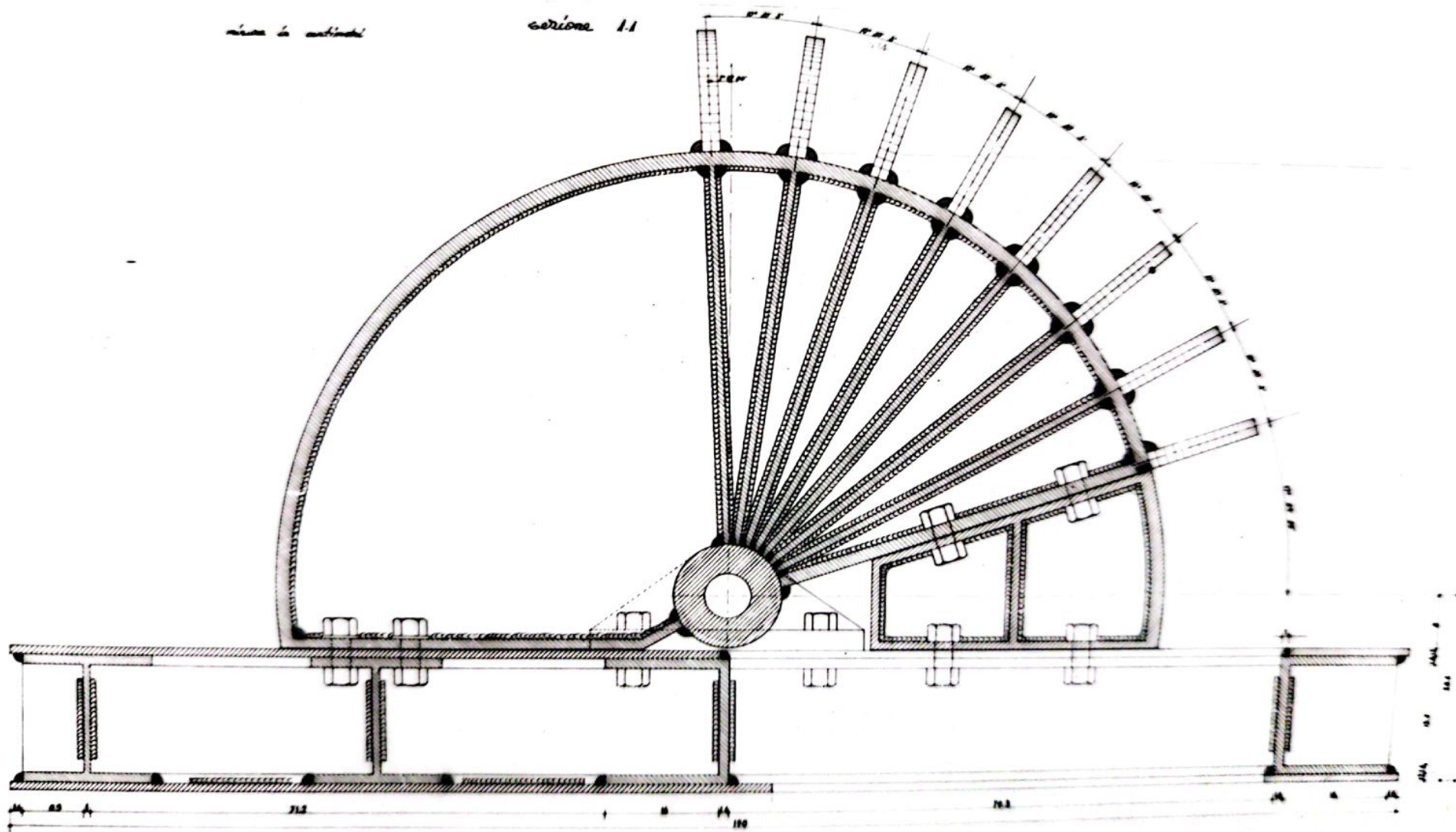

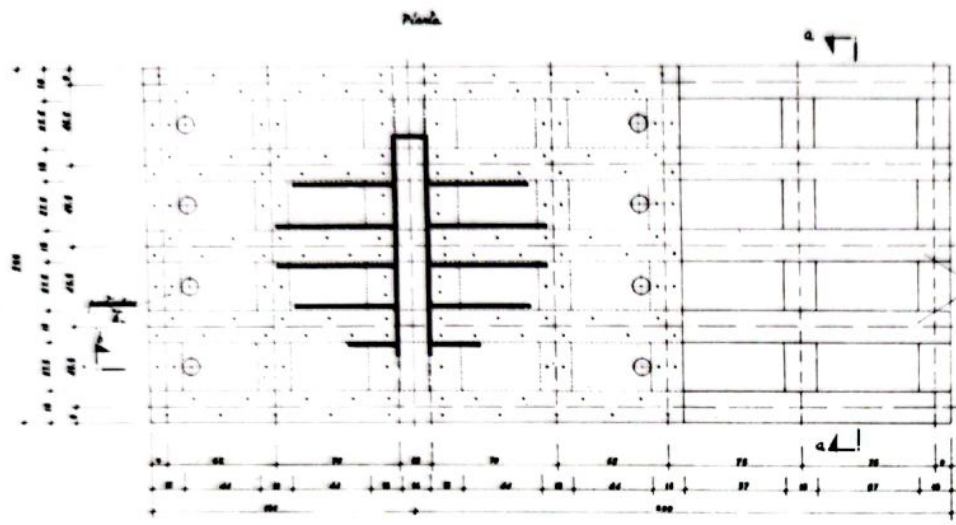

3 lettere indicate in piano
base il diametro di r

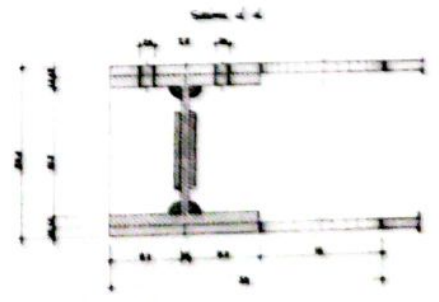
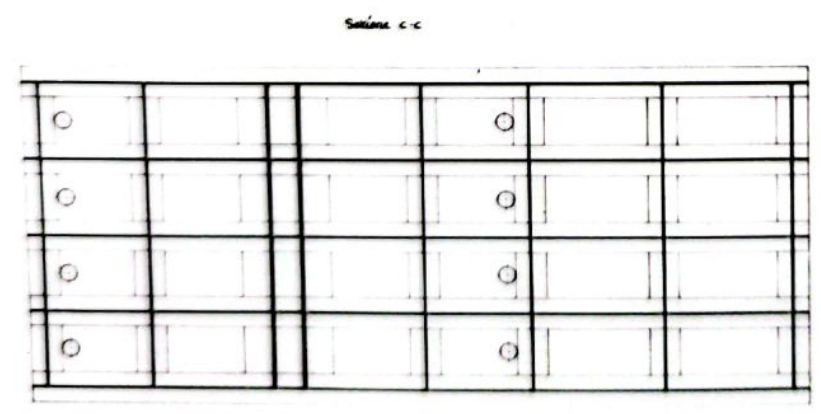
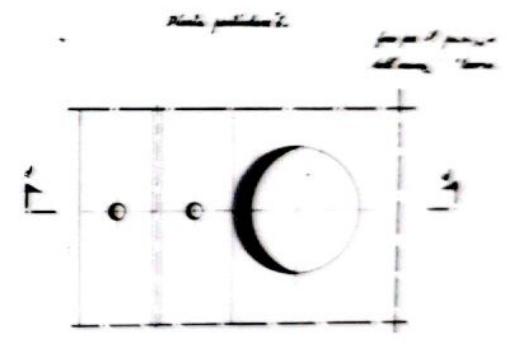

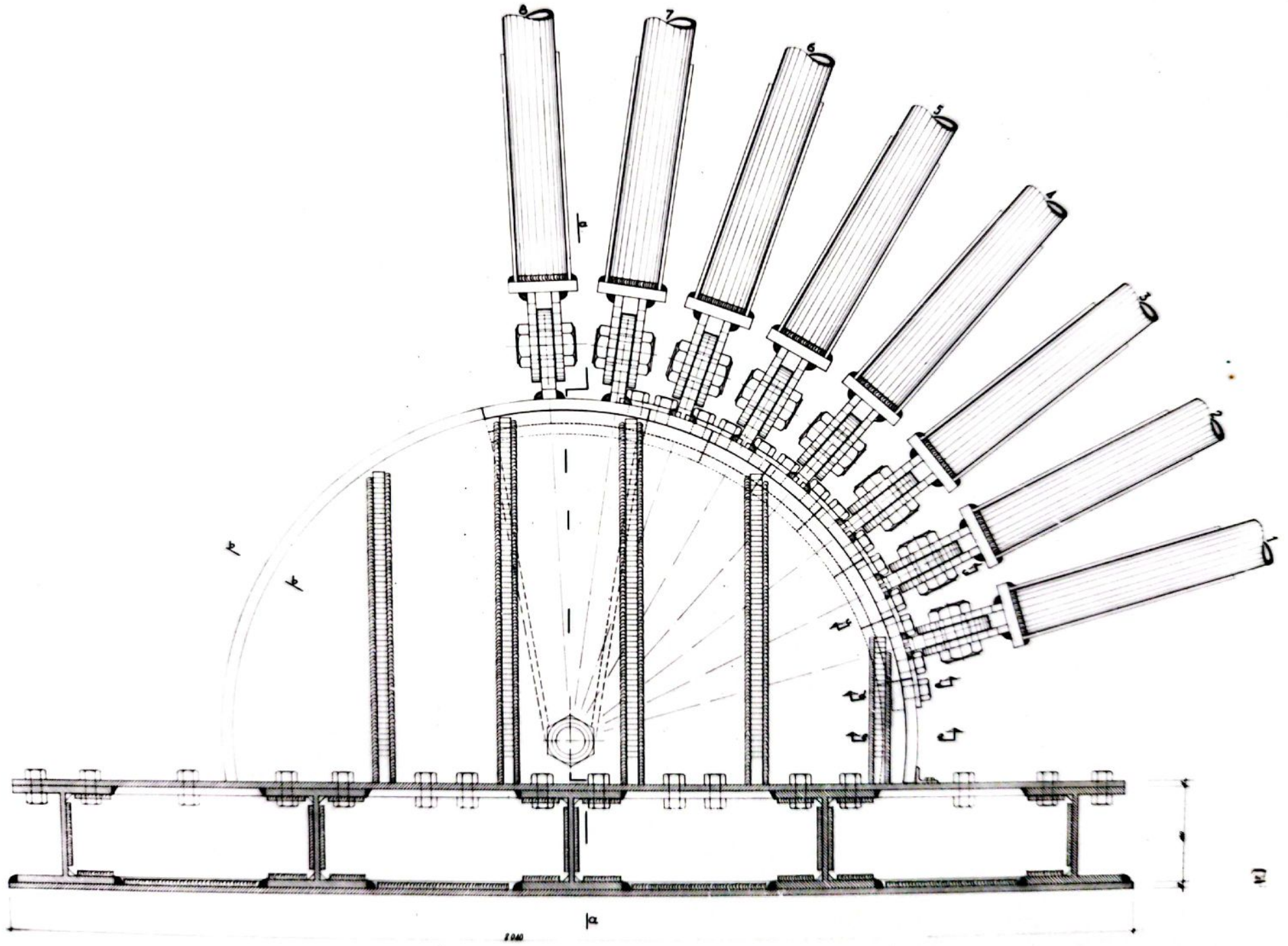

- VISTA FRONTALE DELL'APPARECCHIO DI ADOGGIO -

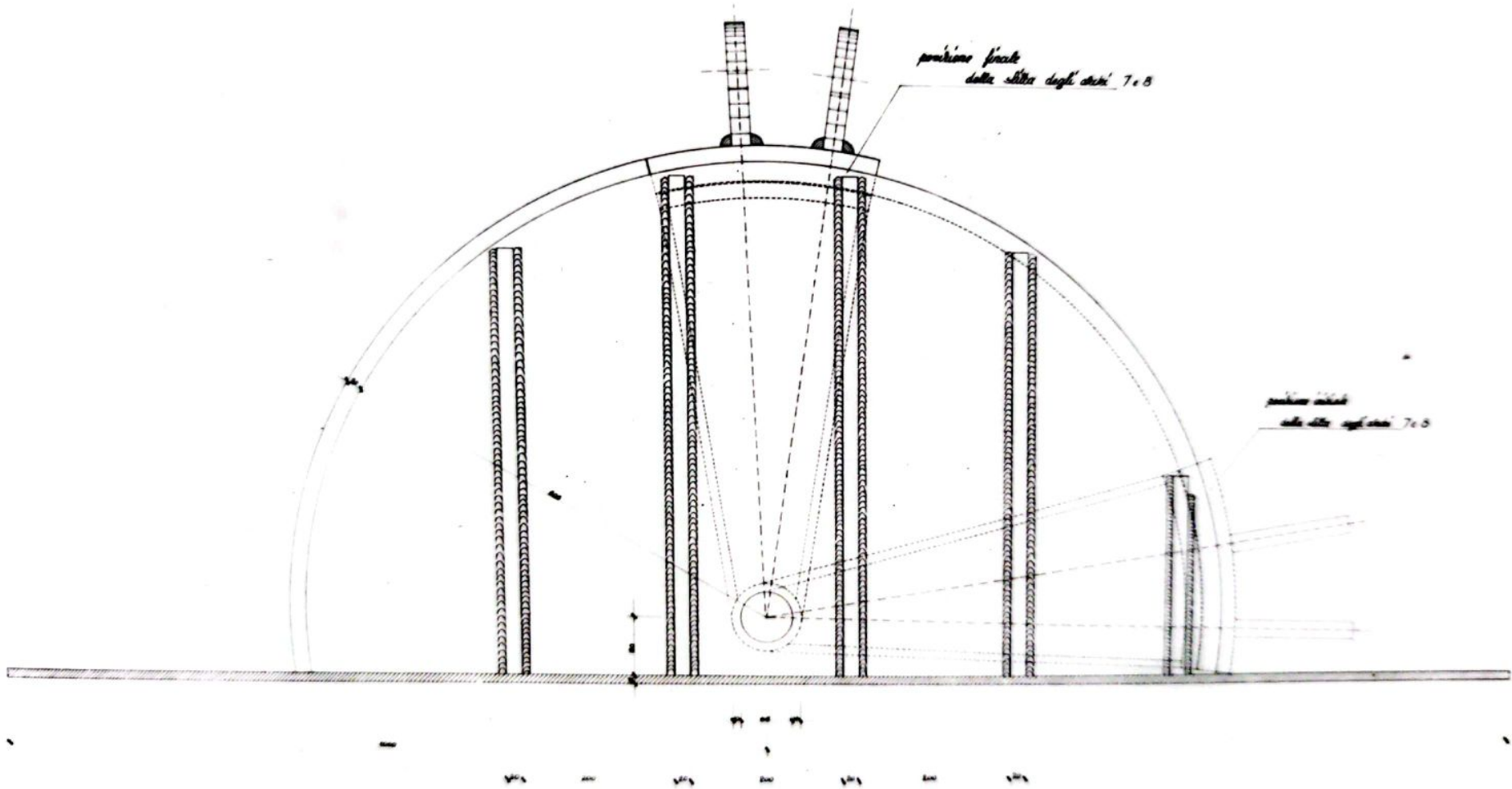

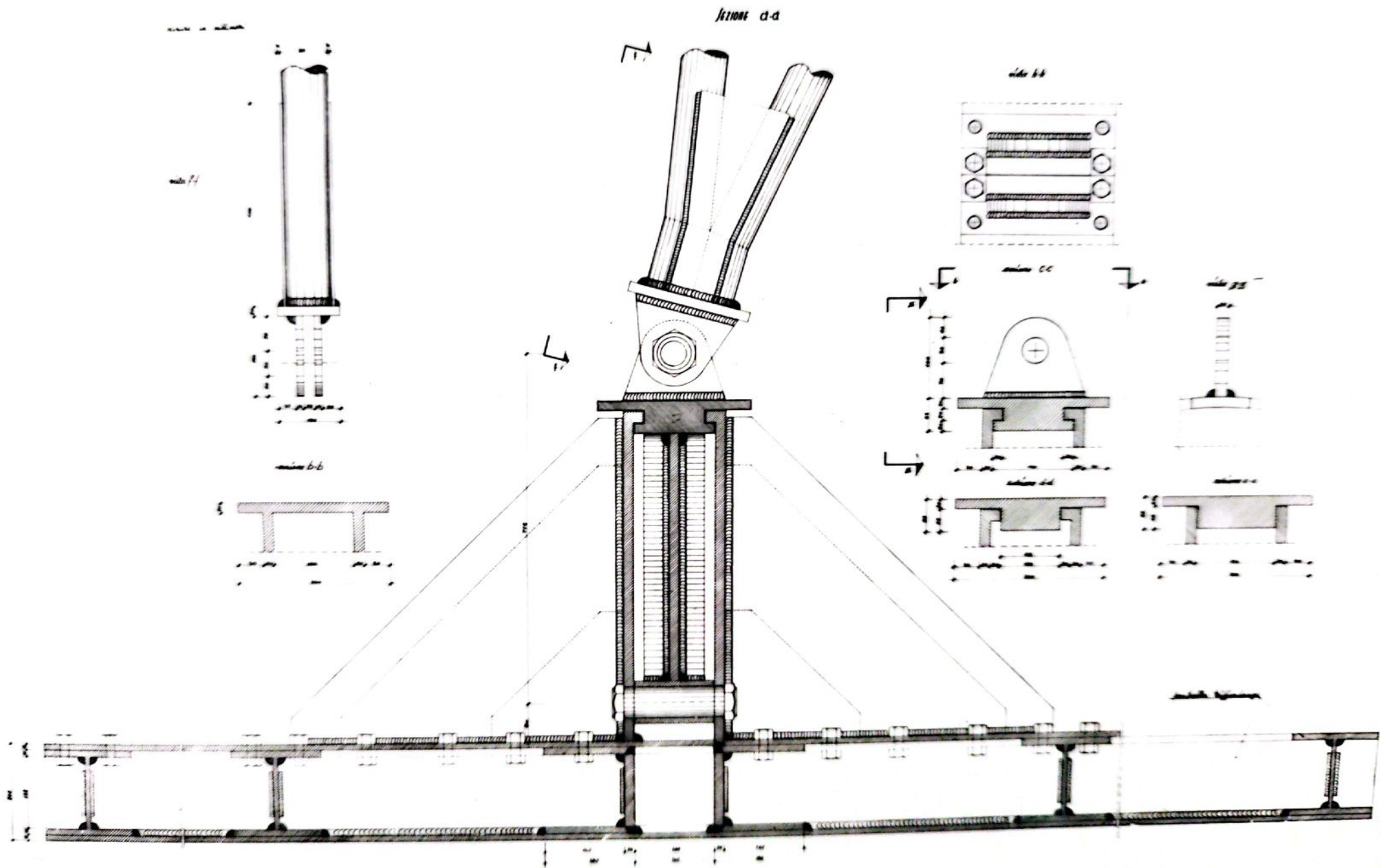

misura in millimetri

vista dall'alto

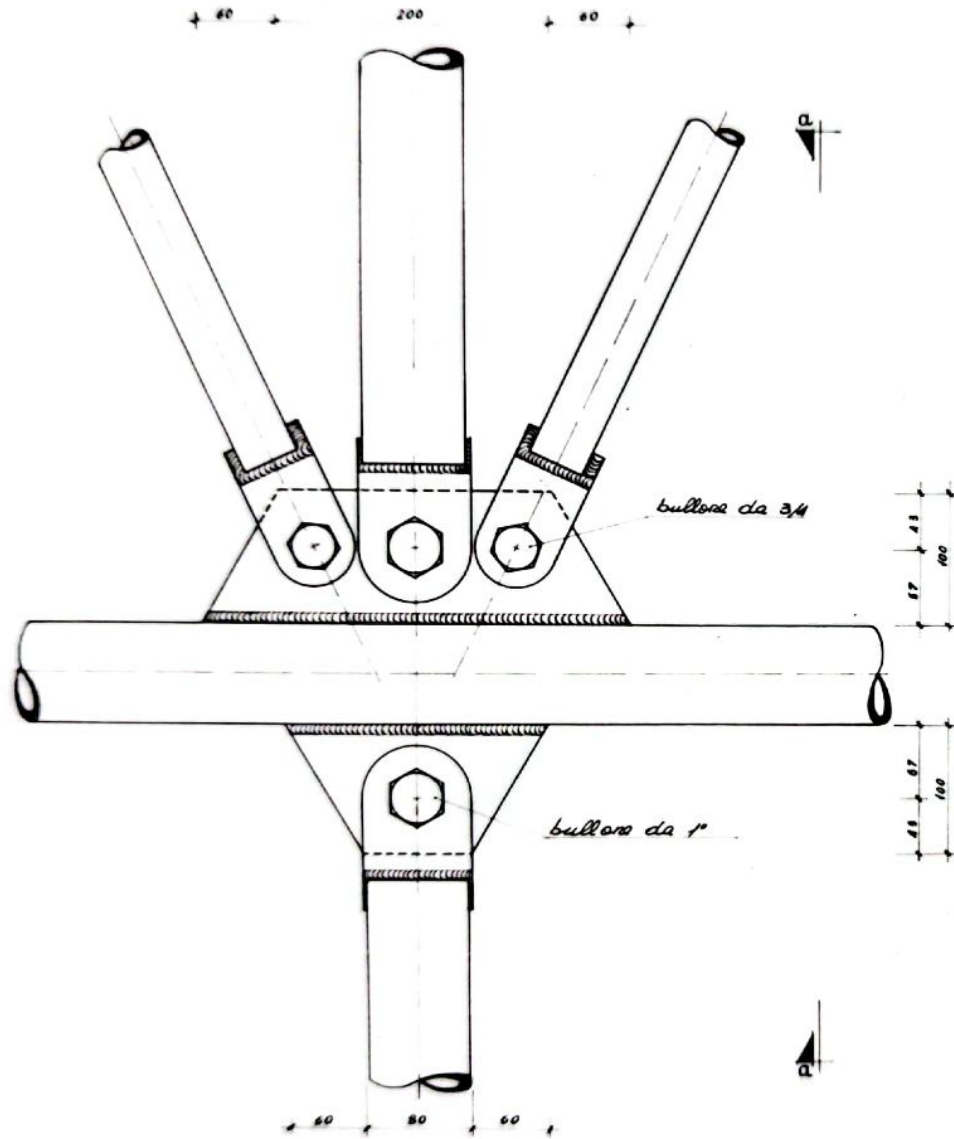

vista a-a

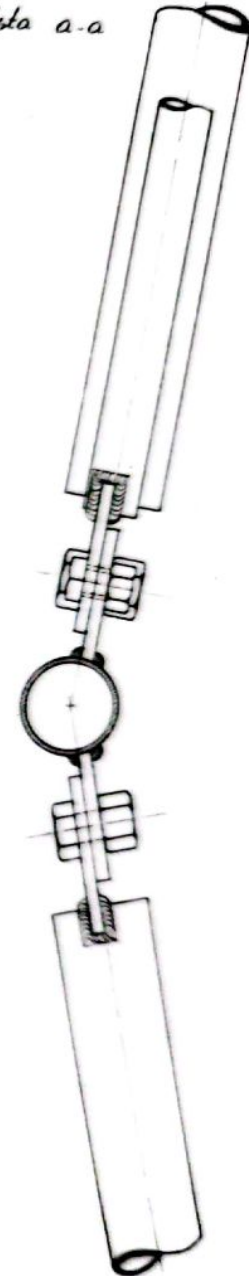

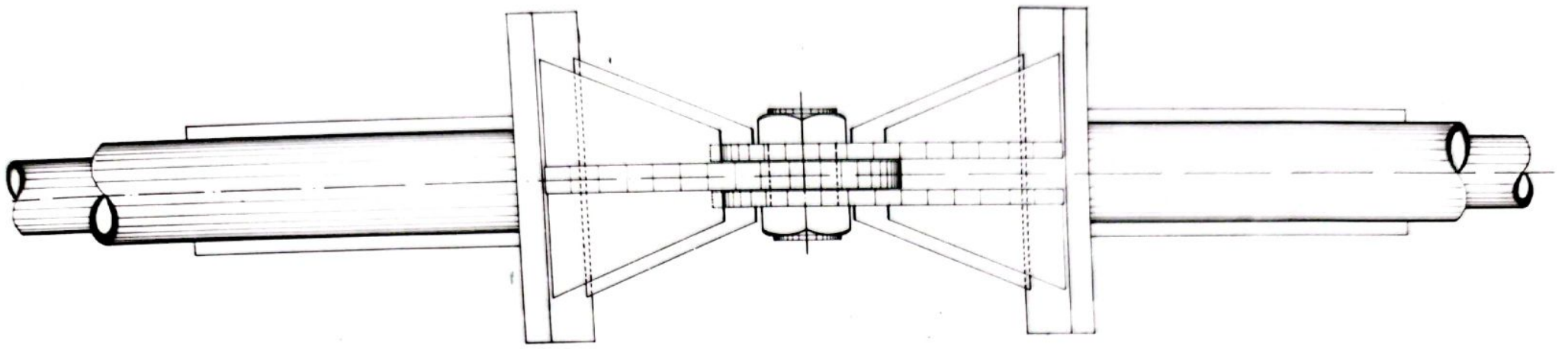

vista dall'alto

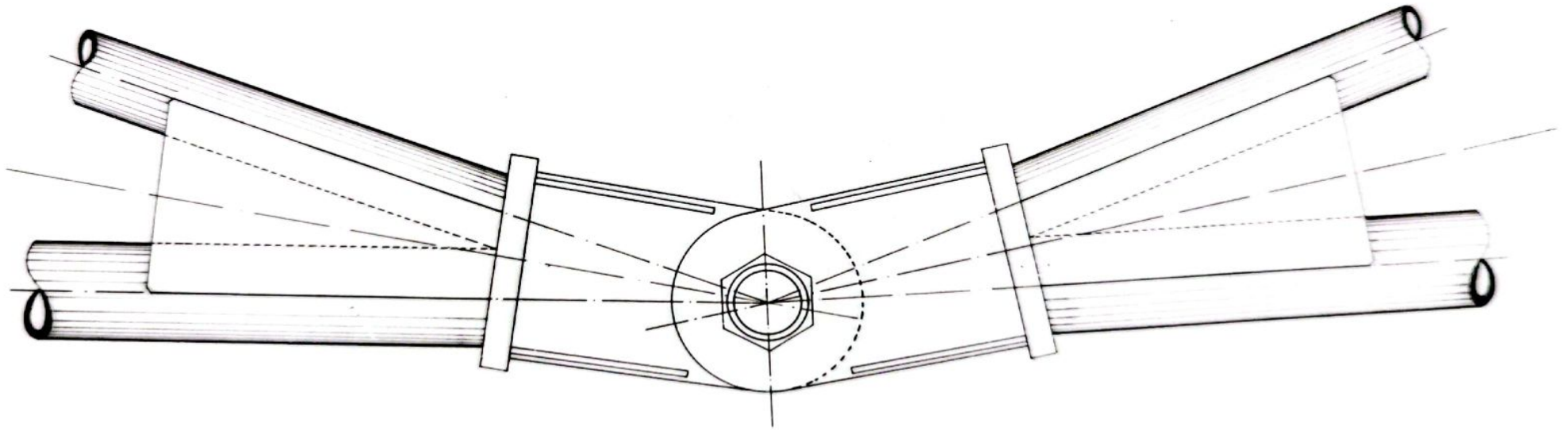

vista di fronte

VITTE INSIEME

Scale 1:1

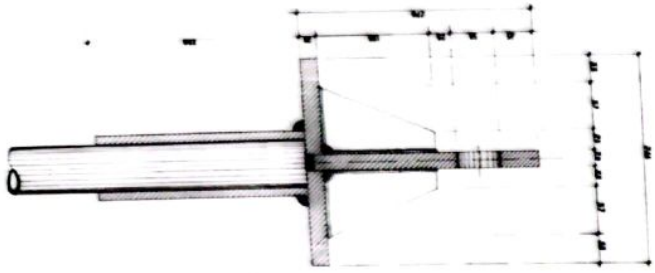

colonna a-e



hardware dell'asse

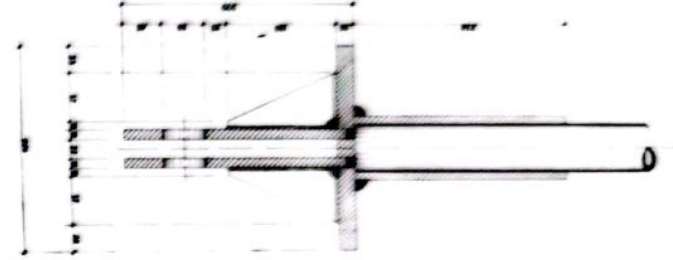

colonna a-d

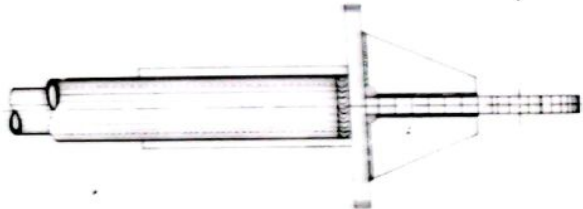

colonna dall'alto

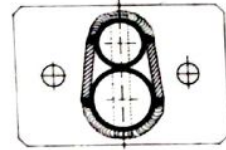

colonna d-d

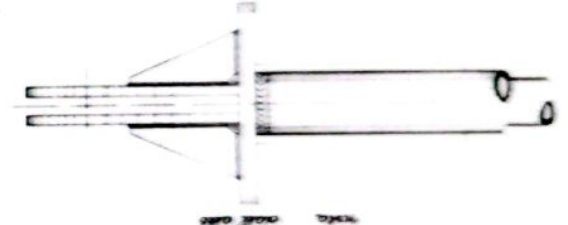

colonna dall'alto

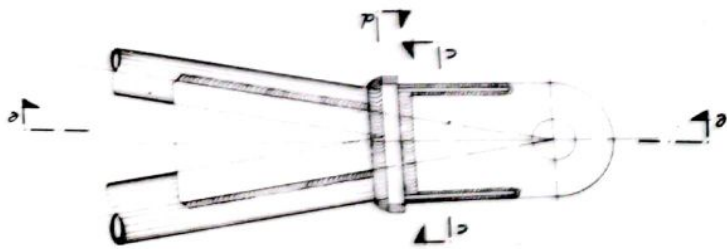

ELEMENTO DI DESTRA
vista frontale

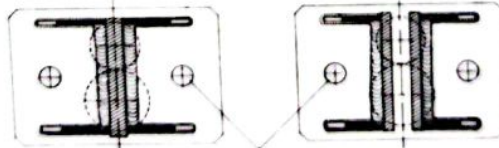

colonna c-c

colonna b-b

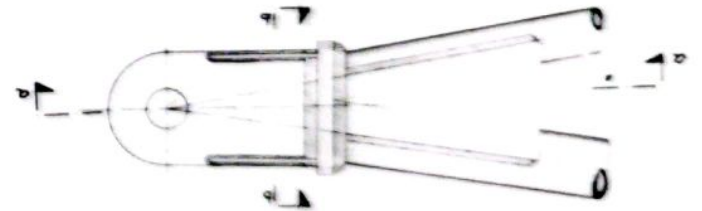

ELEMENTO DI SINISTRA
vista frontale

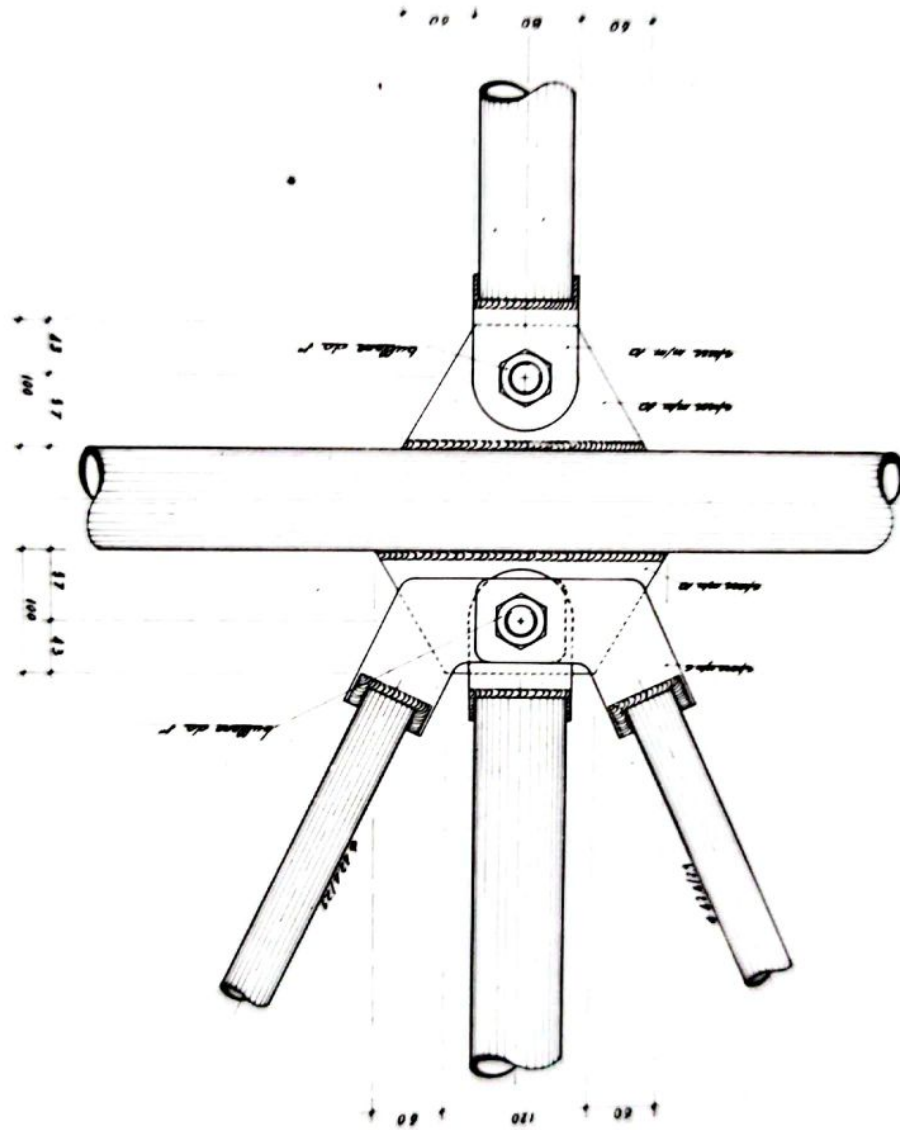

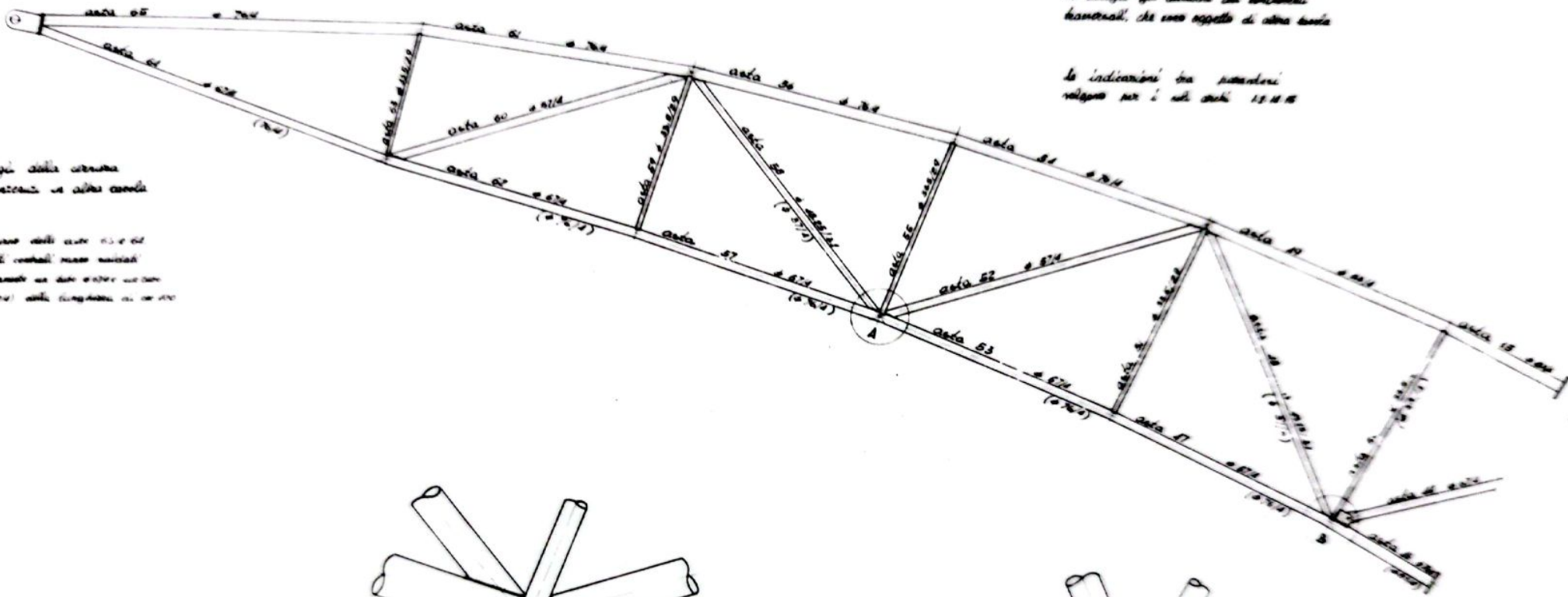

Nota
 Per chiarezza non sono riportati
 in disegno gli attacchi dei componenti
 horizontali, che sono oggetto di altra tavola

Le indicazioni tra parentesi
 valgono per i nodi anche 13 e 14

7 nastri della armatura
 sono contenuti in ogni nodo

Gli nodi sono tutti a 13 e 14
 su tutti i nodi sono presenti
 necessariamente un dato numero di nastri
 e 13 e 14 della armatura di cui 13 e 14

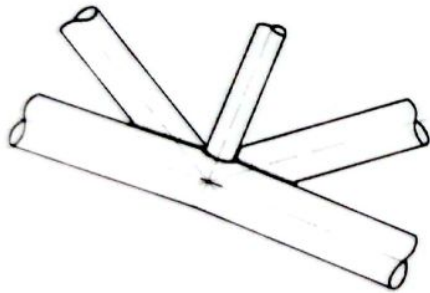

particolare A. 18

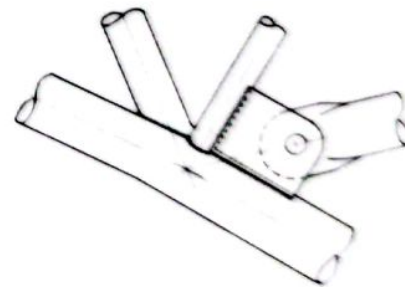

particolare B. 18

Nota
 Per comodità dei suoi lettori
 si dispone qui accanto un prospetto
 strutturale che sarà uguale a quello sopra

Le indicazioni tra parentesi
 stanno ad indicare il tipo di

asse verticale

1888 - 1889

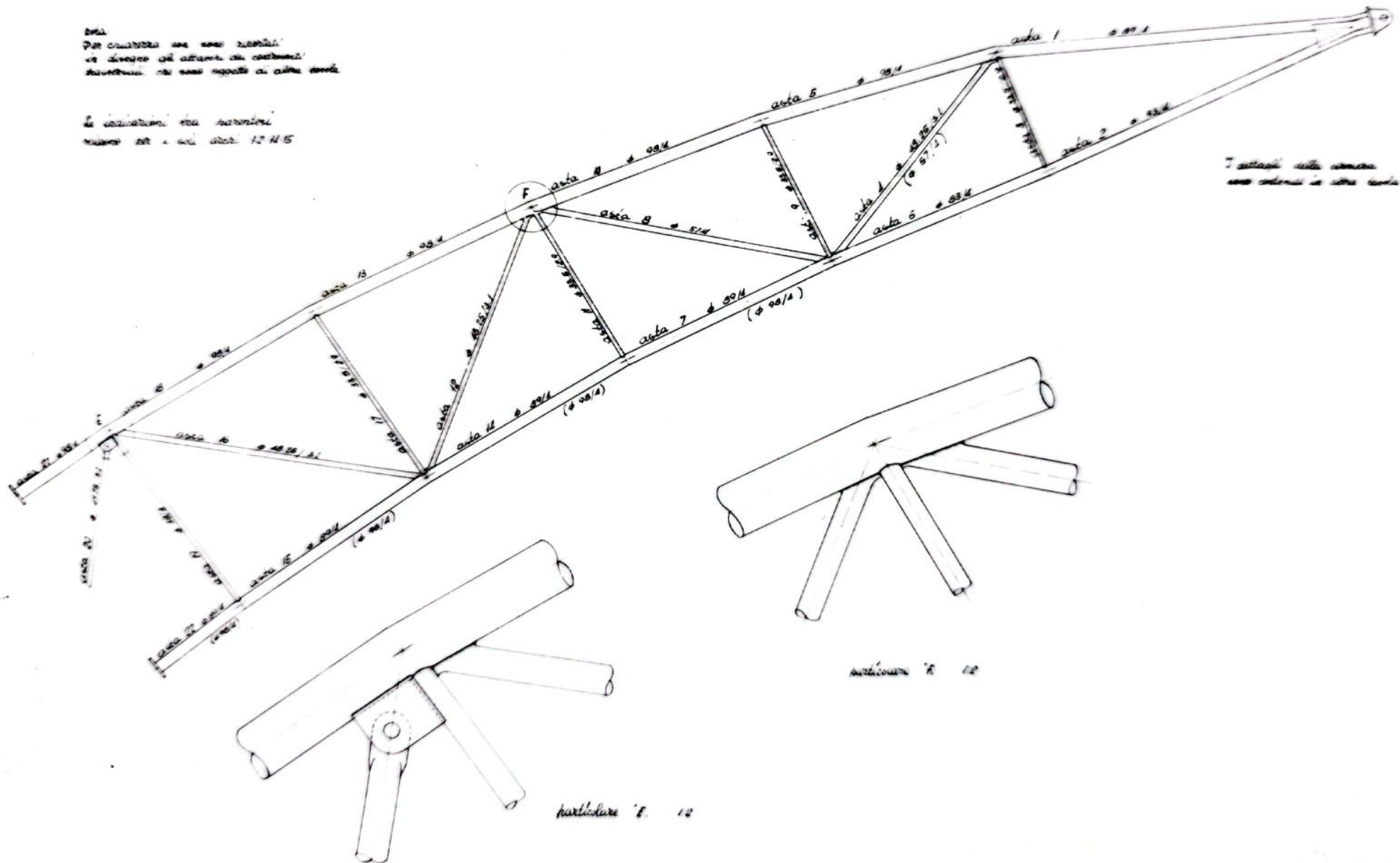

7 particolari della struttura
 sono contenuti in altra tavola

particolare 7

particolare 8

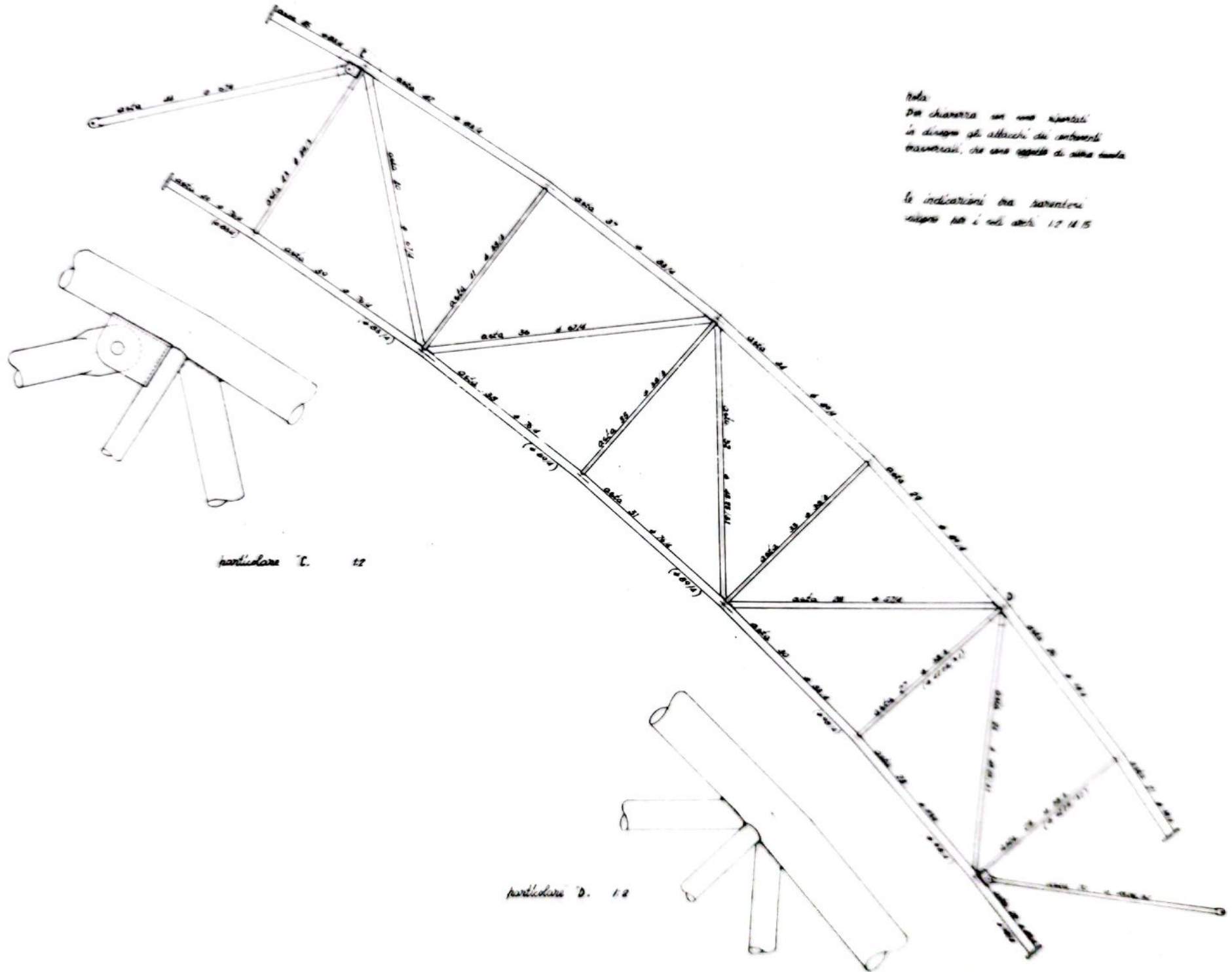

Nota
 Da chiarire in una risposta
 in disegno gli attacchi dei membri
 trasversali, che sono oggetti di altra tavola

le indicazioni tra parentesi
 rispetto alle aste 12, 14, 15

particolare C. 12

particolare D. 12

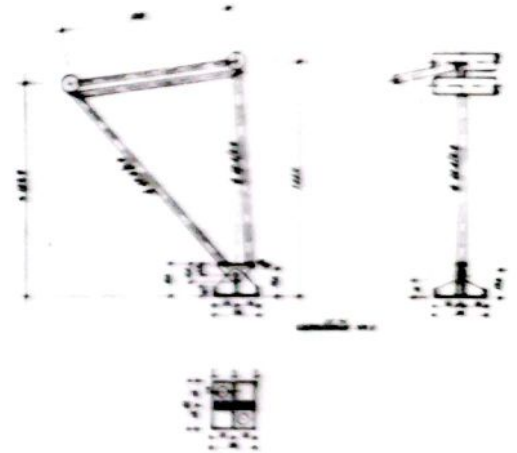
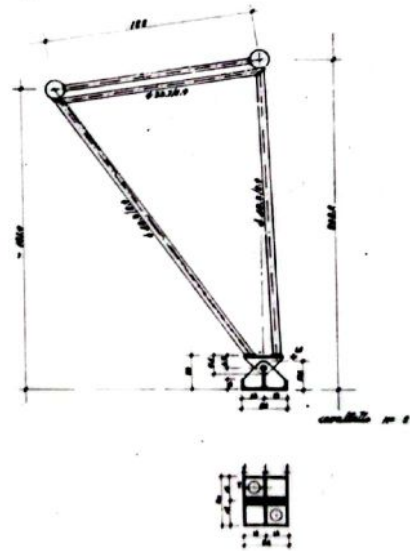
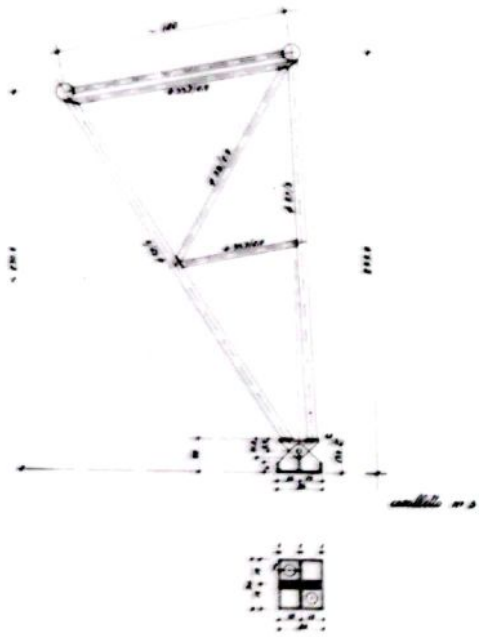

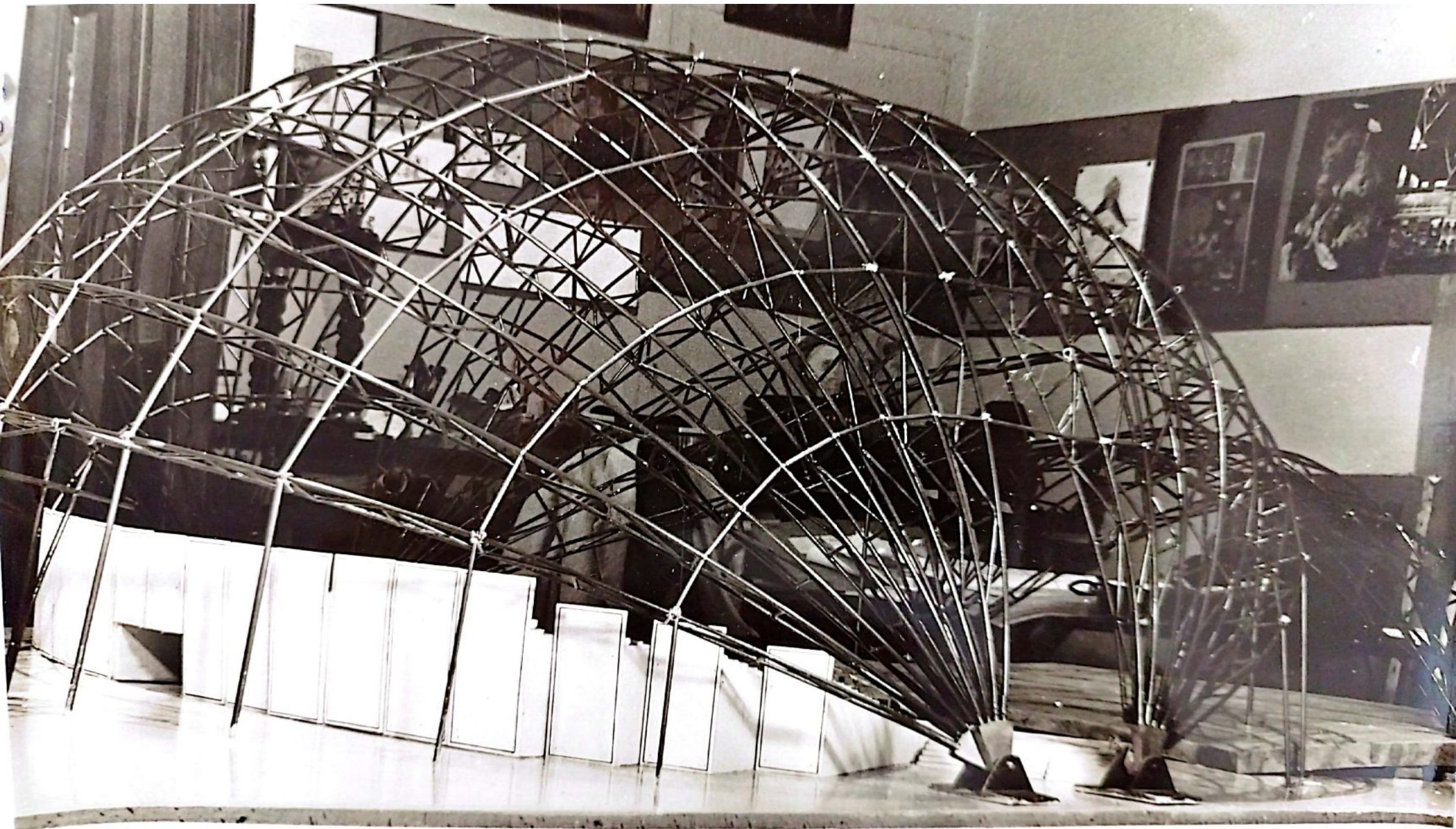

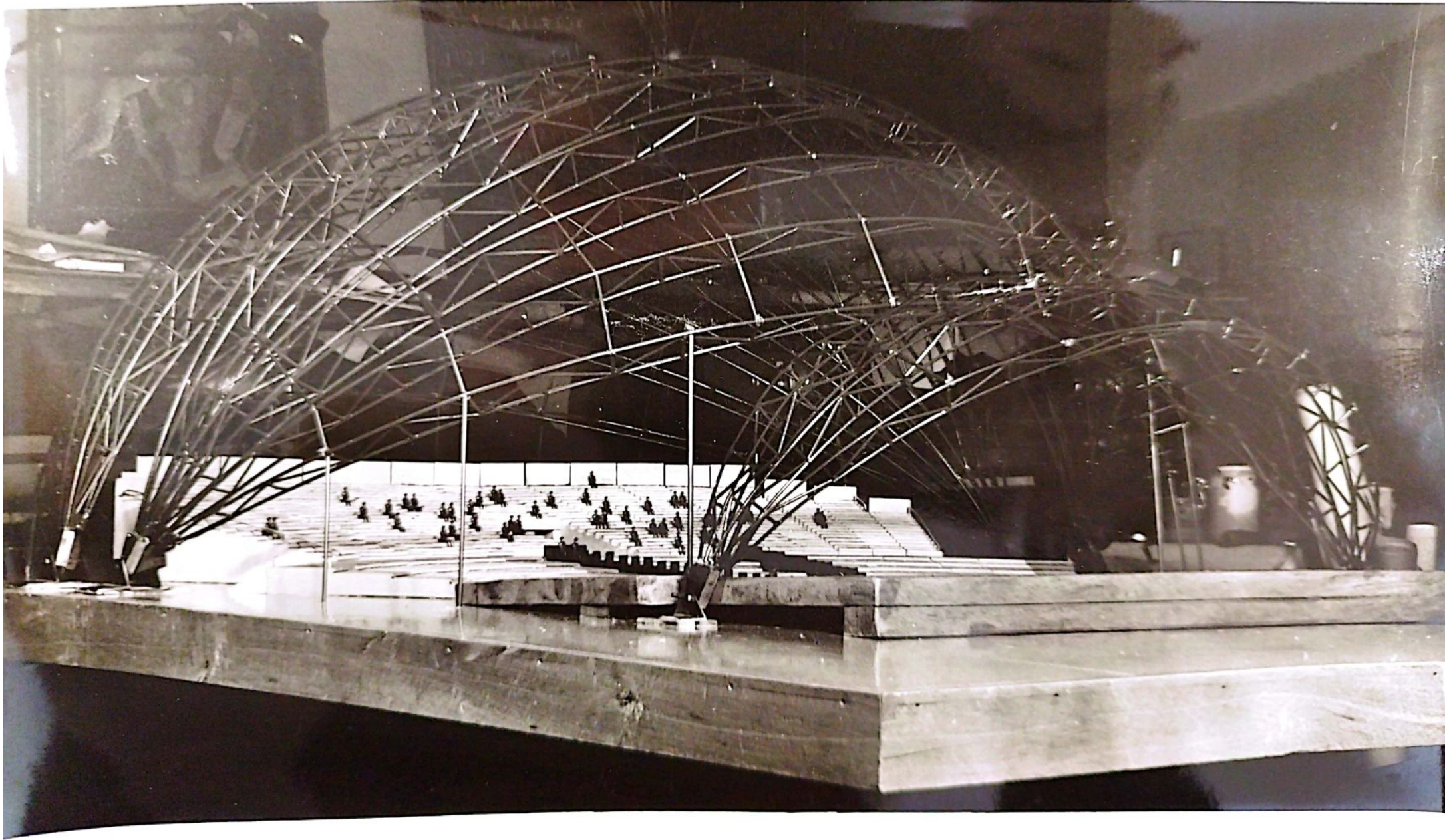

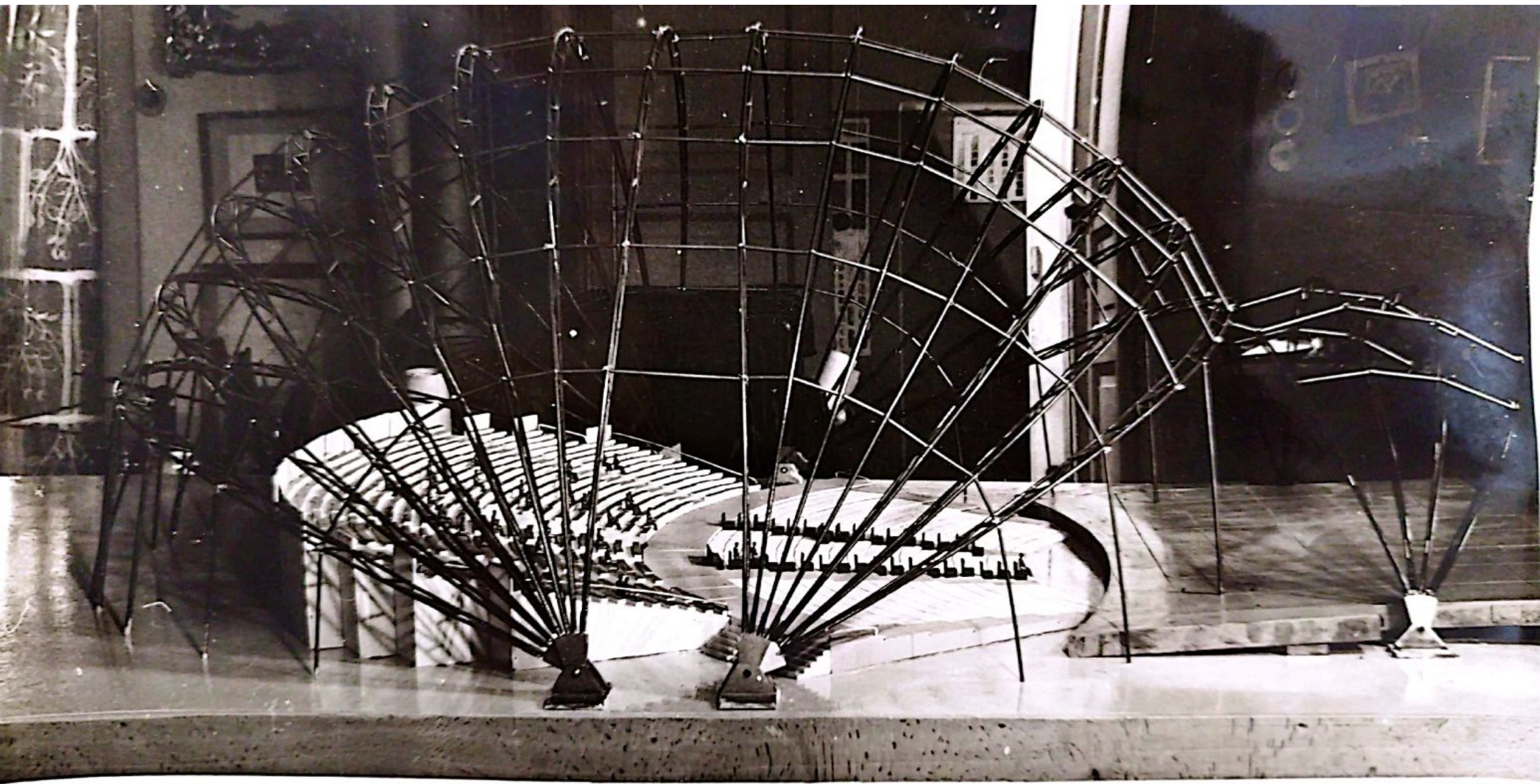

PUBLIFOTO

Agenzia Fotografica

Via Fiorentini 61 - Tel. 323.720

≡ Napoli ≡

TELEFONO 10605

TELEFONO 293.942

PIAZZA FOSSATELLO 1 - 9



foto VASARI roma

69640

foto **VASARI** roma

FOTOGRAFICO EDITORE

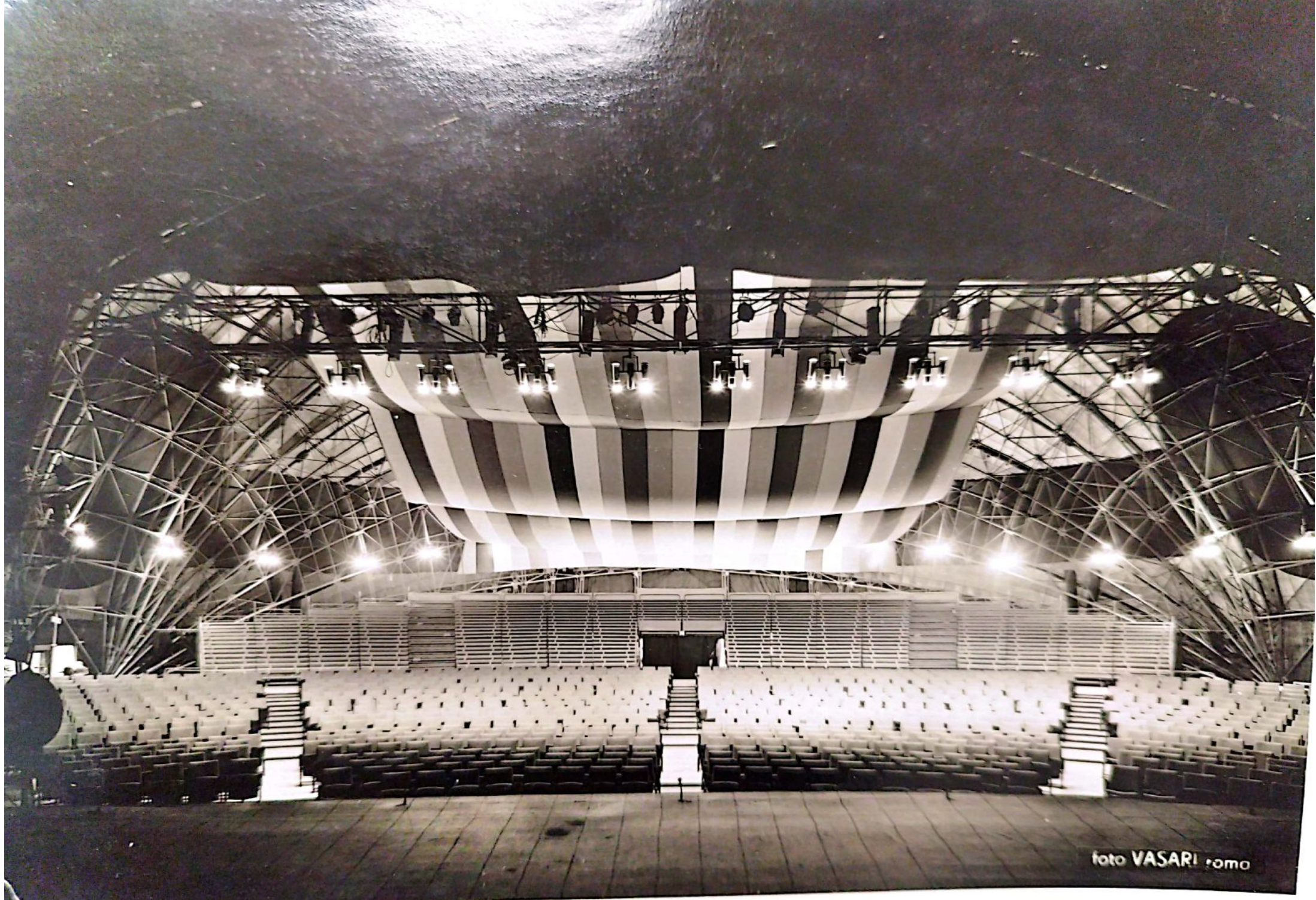
Via Condotti, 39 - Piazza Esedra, 61 - Via Ludovisi, 6

Proprietà artistica riservata a norma delle leggi vigenti nello Stato
e nei Trattati Internazionali

In caso di pubblicazione è obbligatorio citare:

foto **VASARI** roma



foto VASARI romc

68889

Libreria N

foto **VASARI** roma

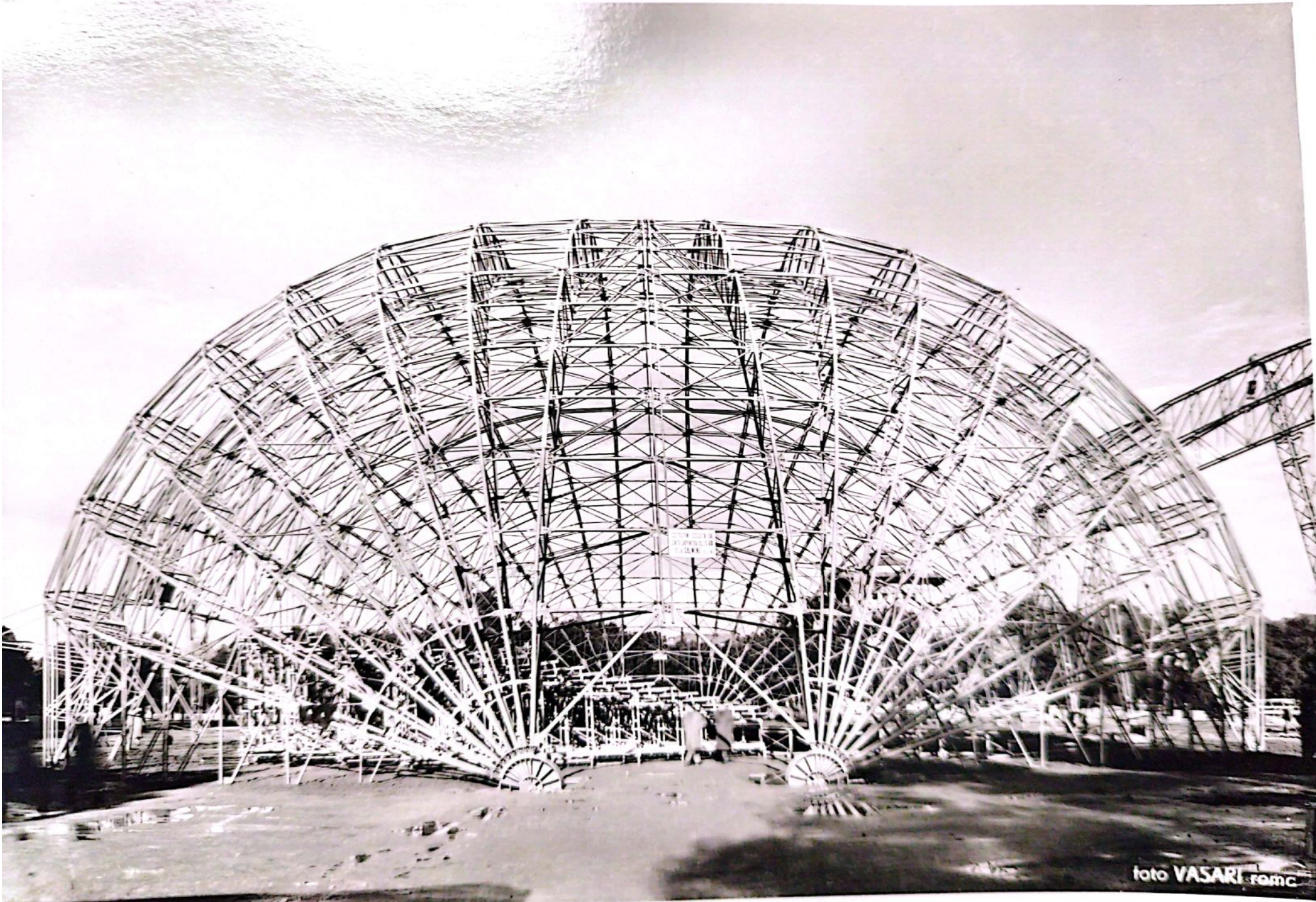
FOTOGRAFO EDITORE

Via Condotti, 39 - Piazza Esedra, 61 - Via Ludovisi, 6

Proprietà artistica riservata a norma delle leggi vigenti nello Stato
e dei Trattati Internazionali.

In caso di pubblicazione è obbligatorio citare:

foto **VASARI** roma



foto VASARI roma

Lastra N°

68890

foto VASARI roma

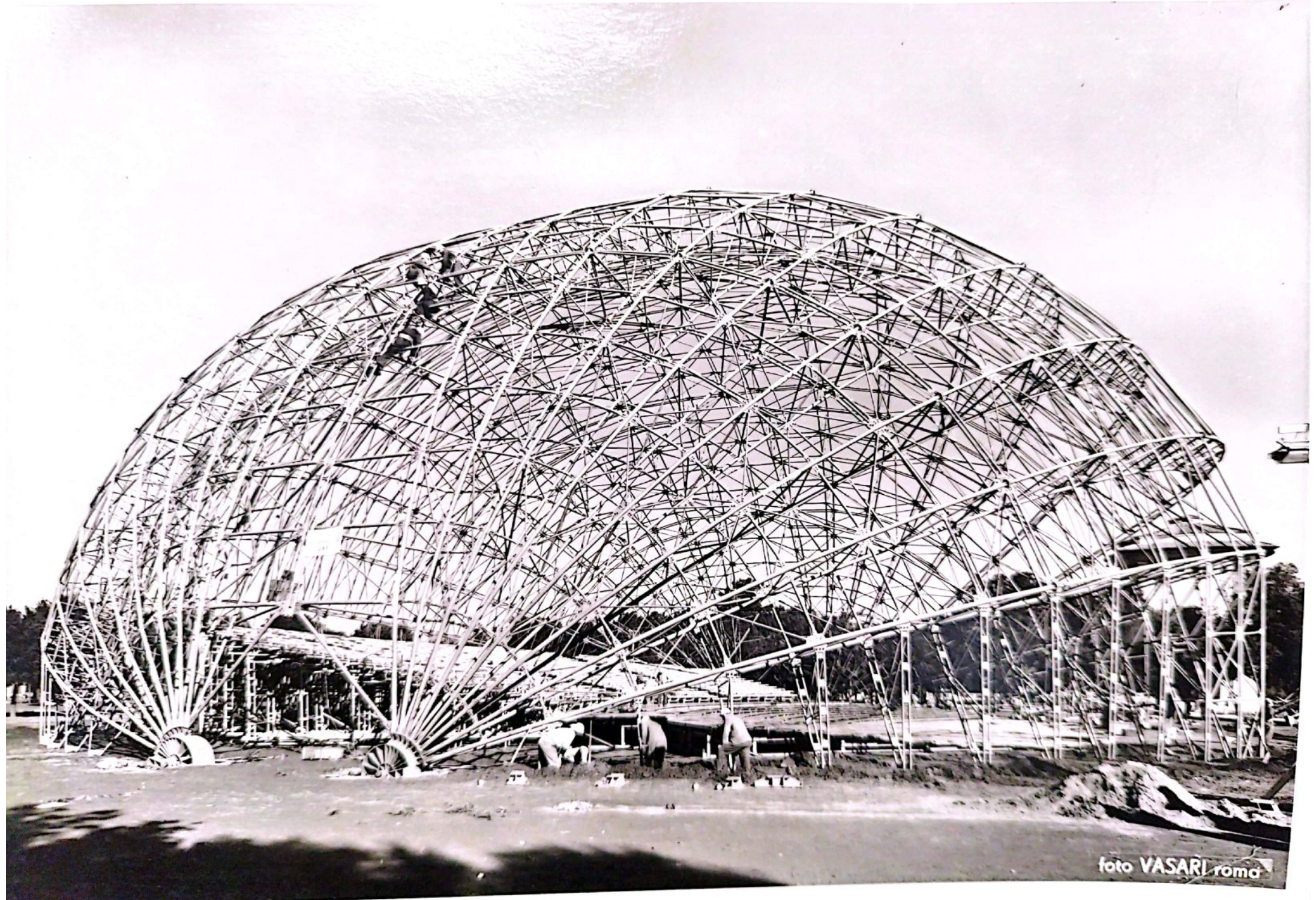
FOTOGRAFO EDITORE

Via Condotti, 39 - Piazza Esedra, 61 - Via Ludovisi, 6

Proprietà artistica riservata a norma delle leggi vigenti nello Stato
e dei Trattati Internazionali

In caso di pubblicazione è obbligatorio citare:

foto VASARI roma

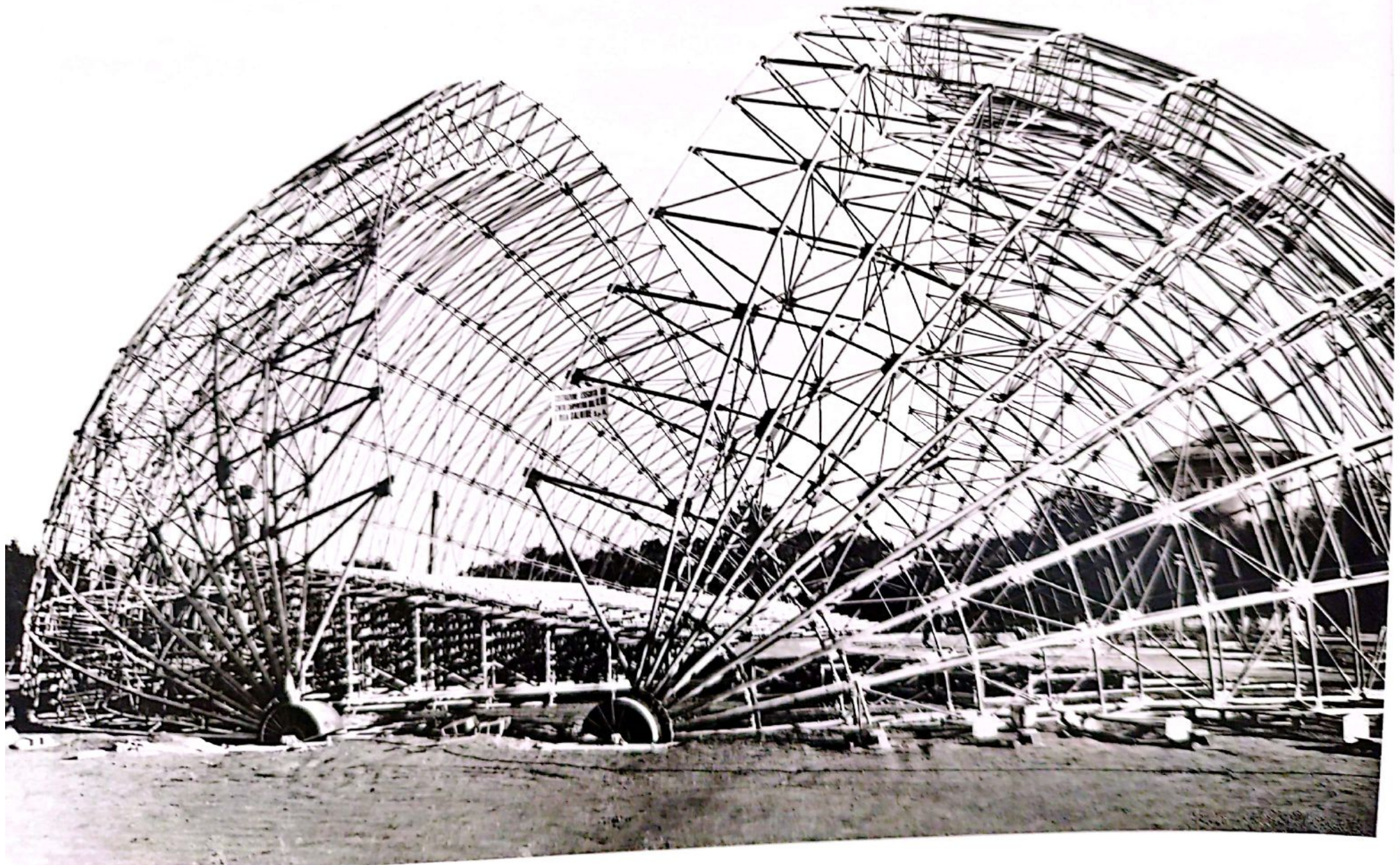

Lastra N° 68829

foto VASARI roma

FOTOGRAFO EDITORE

Via Condotti, 39 - Piazza Esedra, 61 - Via Ludovisi, 6

Proprietà artistica riservata a norma delle leggi vigenti nello Stato
e dei Trattati Internazionali.

In caso di pubblicazione è obbligatorio citare:

foto VASARI roma



foto VASARI roma

Lastra N°

68830

foto **VASARI** roma

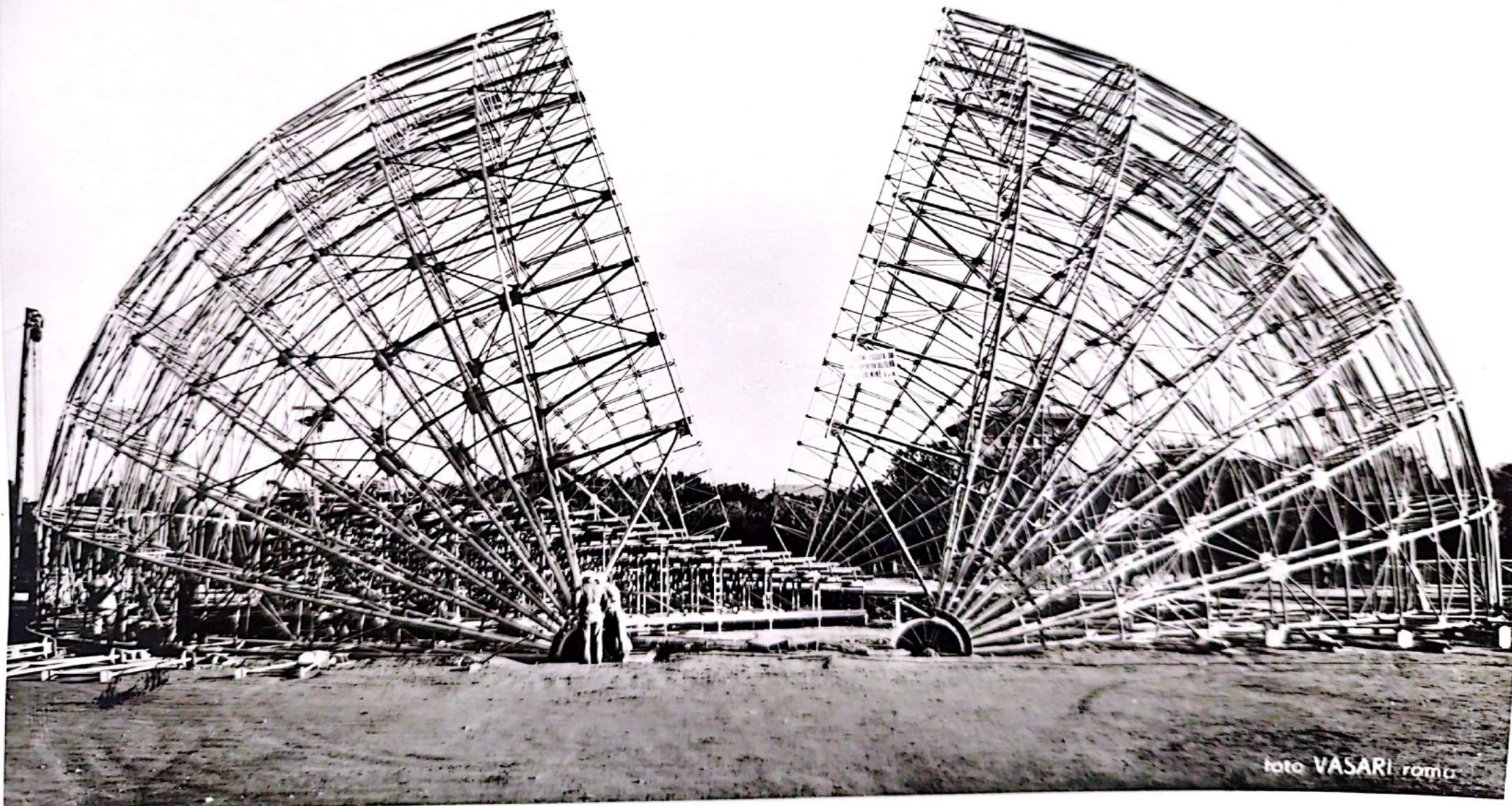
FOTOGRAFO EDITORE

Via Condotti, 39 - Piazza Esedra, 61 - Via Ludovisi, 6

Proprietà artistica riservata a norma delle leggi vigenti nello Stato
e nei Trattati Internazionali.

Per ogni pubblicazione è obbligatorio citare:

foto **VASARI** roma

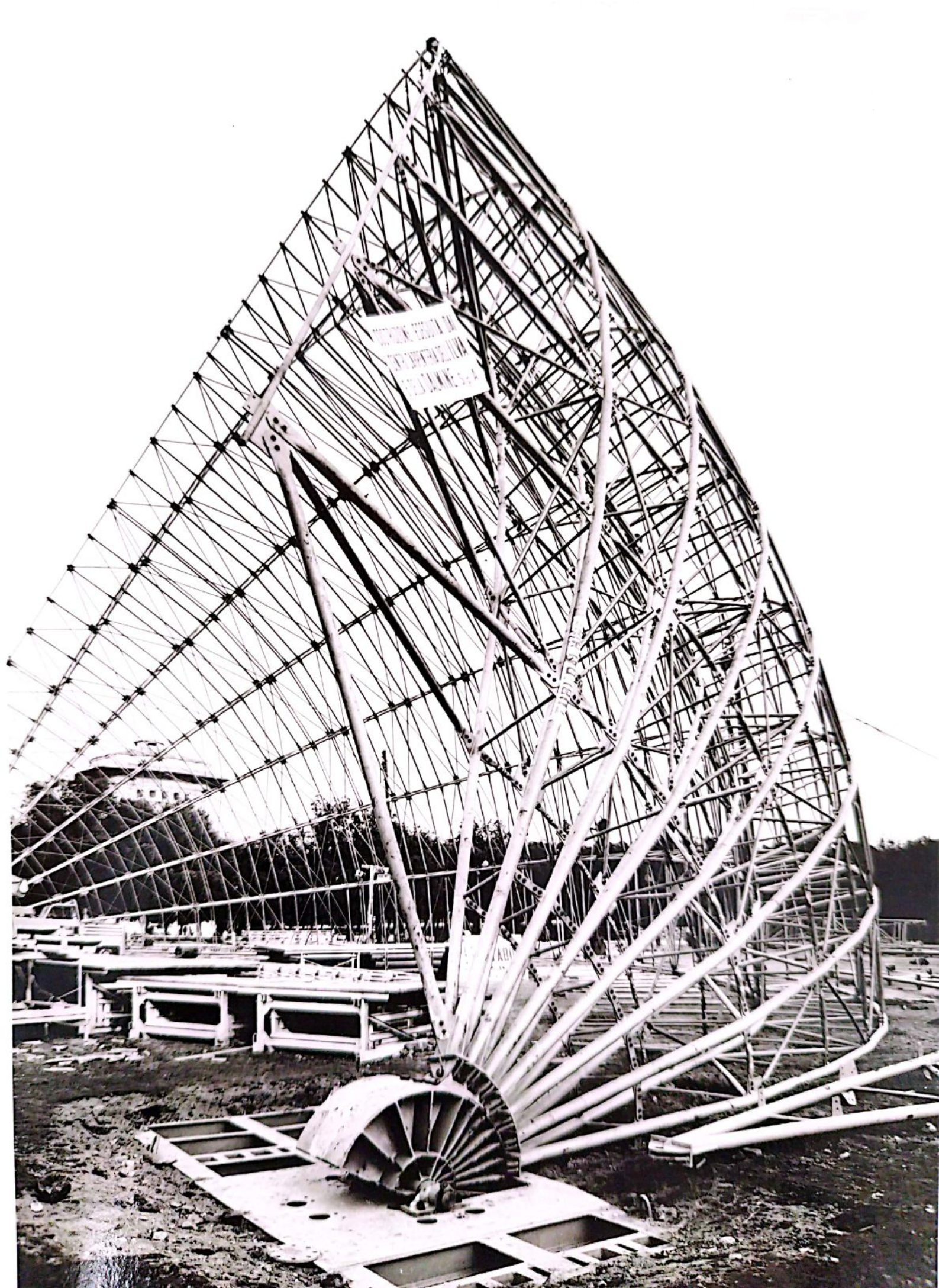







foto VAS



foto VASARI roma

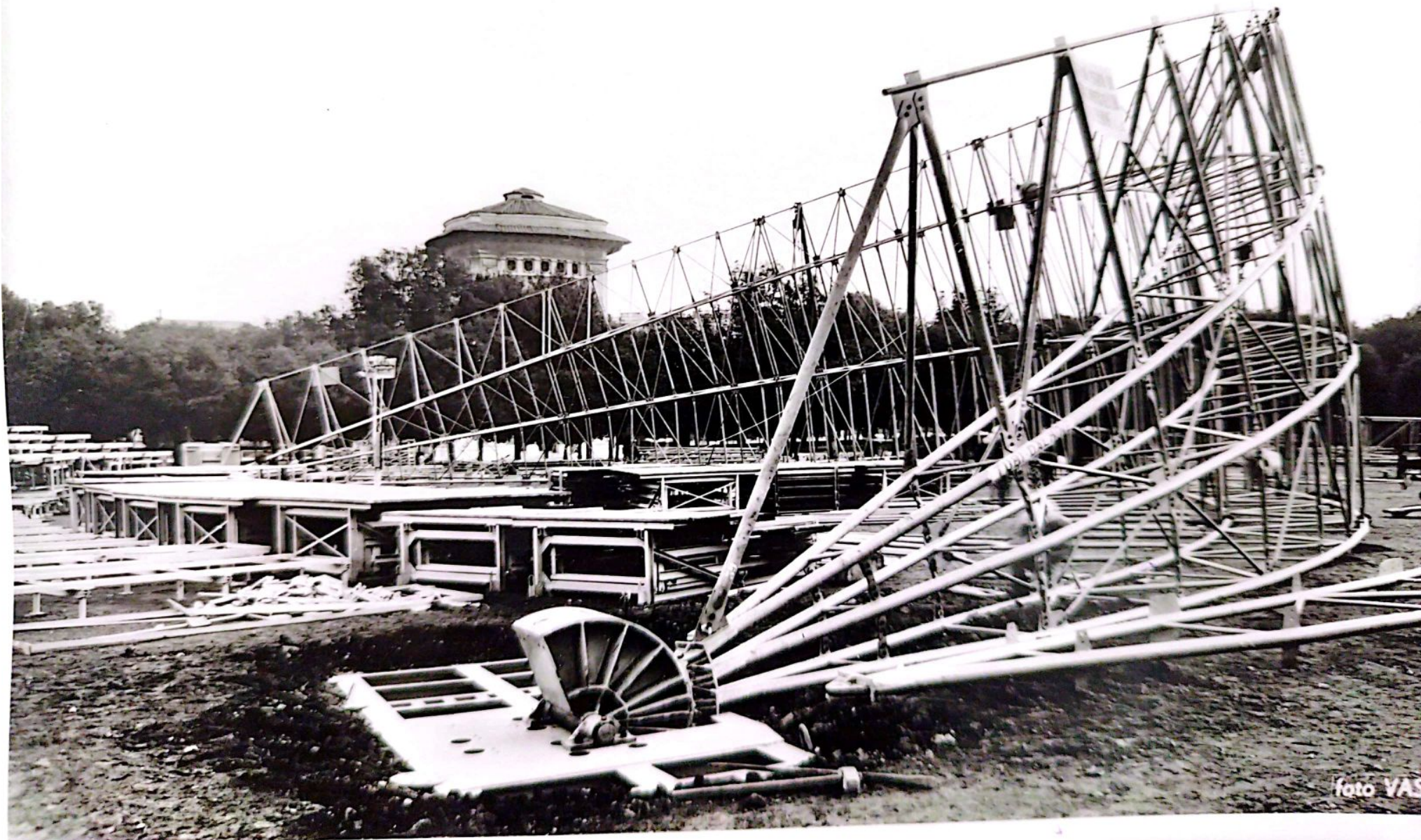

foto VASARI roma



foto VASARI roma

Lastra N. 68832

foto VASARI roma

FOTOGRAFO EDITORE

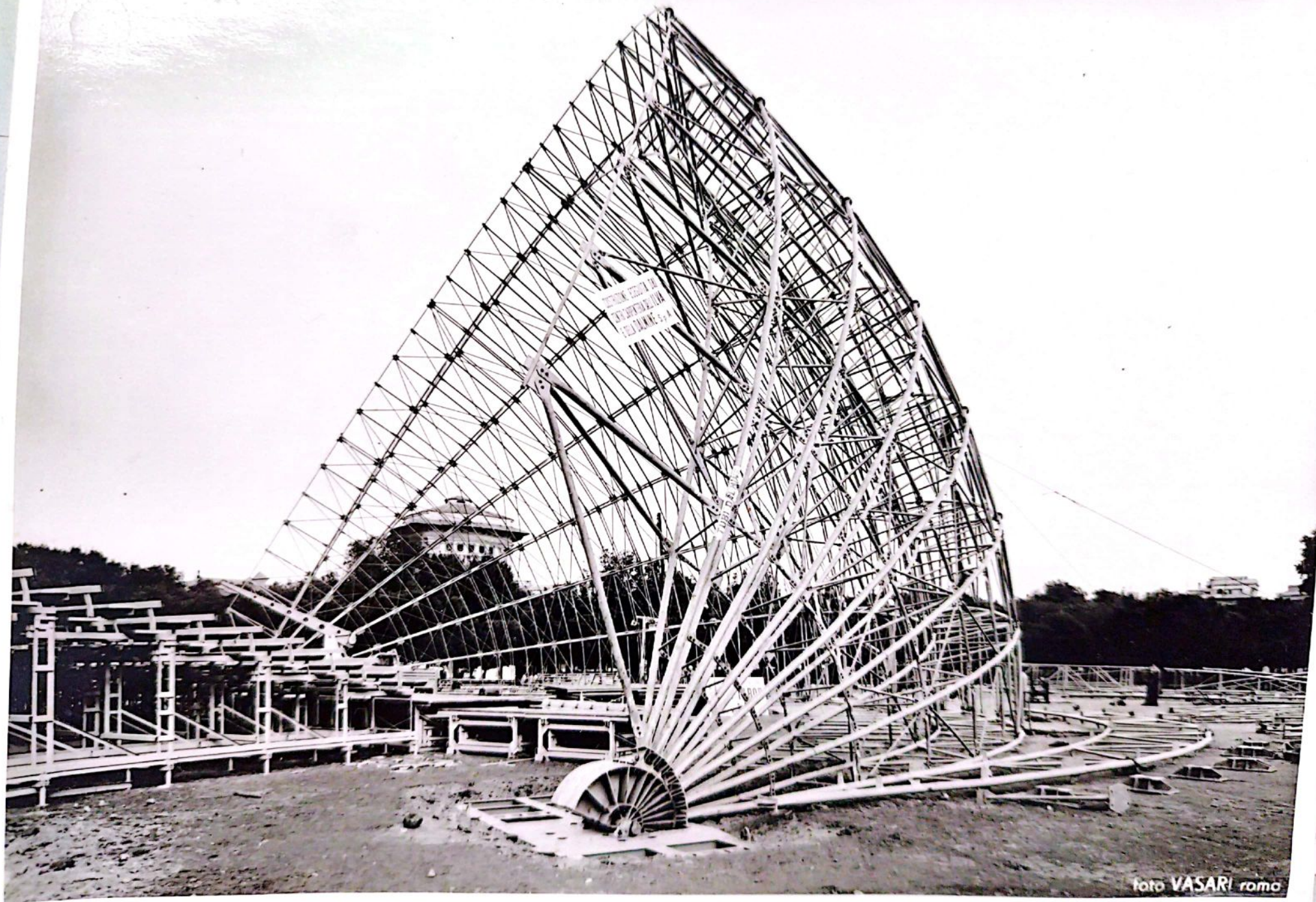
Via Condotti, 39 - Piazza Esedra, 61 - Via Ludovisi, 6

Proprietà artistica riservata a norma delle leggi vigenti nello Stato
e dei Trattati Internazionali.

In caso di pubblicazione è obbligatorio citare:

foto VASARI roma





foto VASARI roma





foto VASARI roma



foto VASARI roma

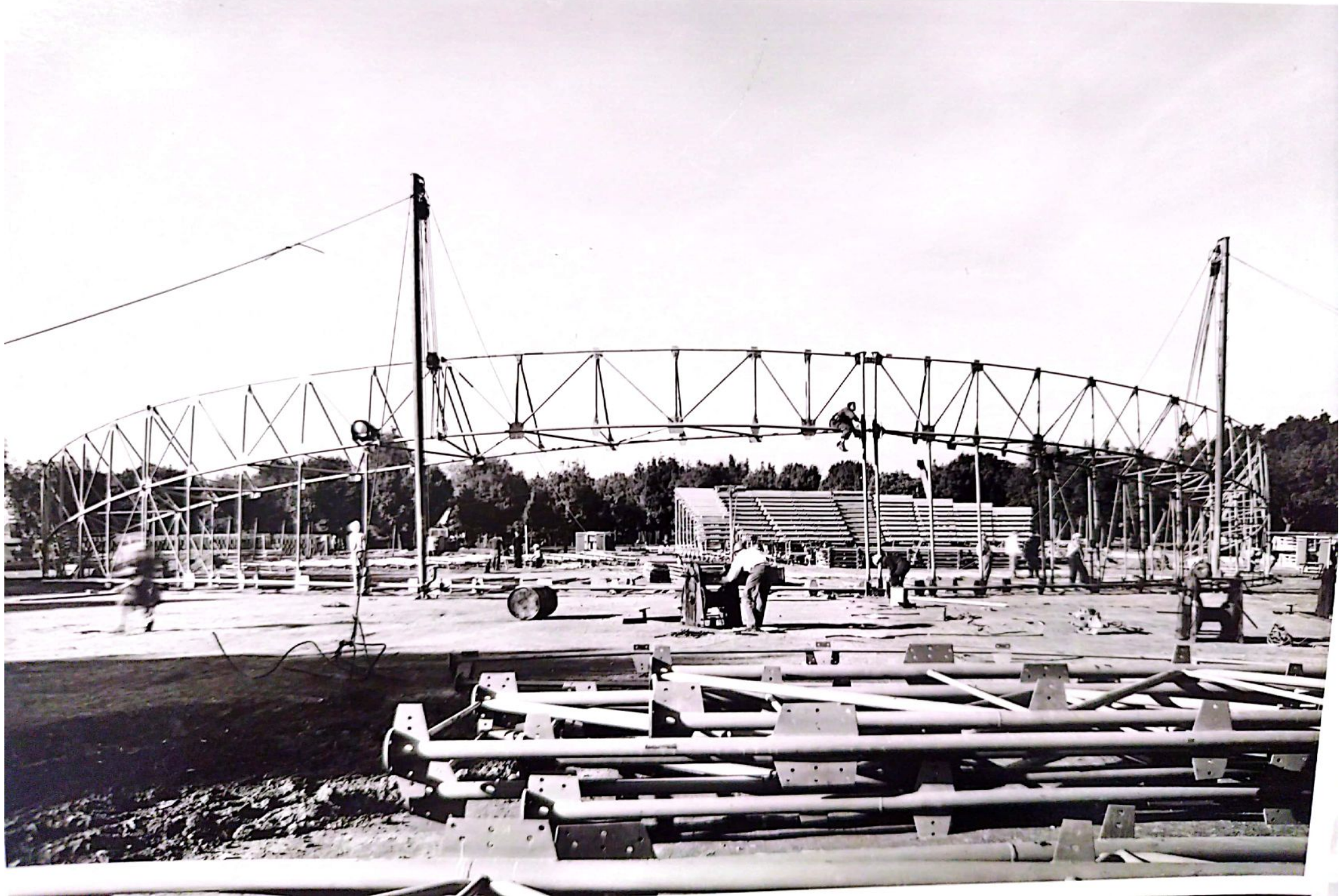

Foto VASARI roma



foto VASARI roma

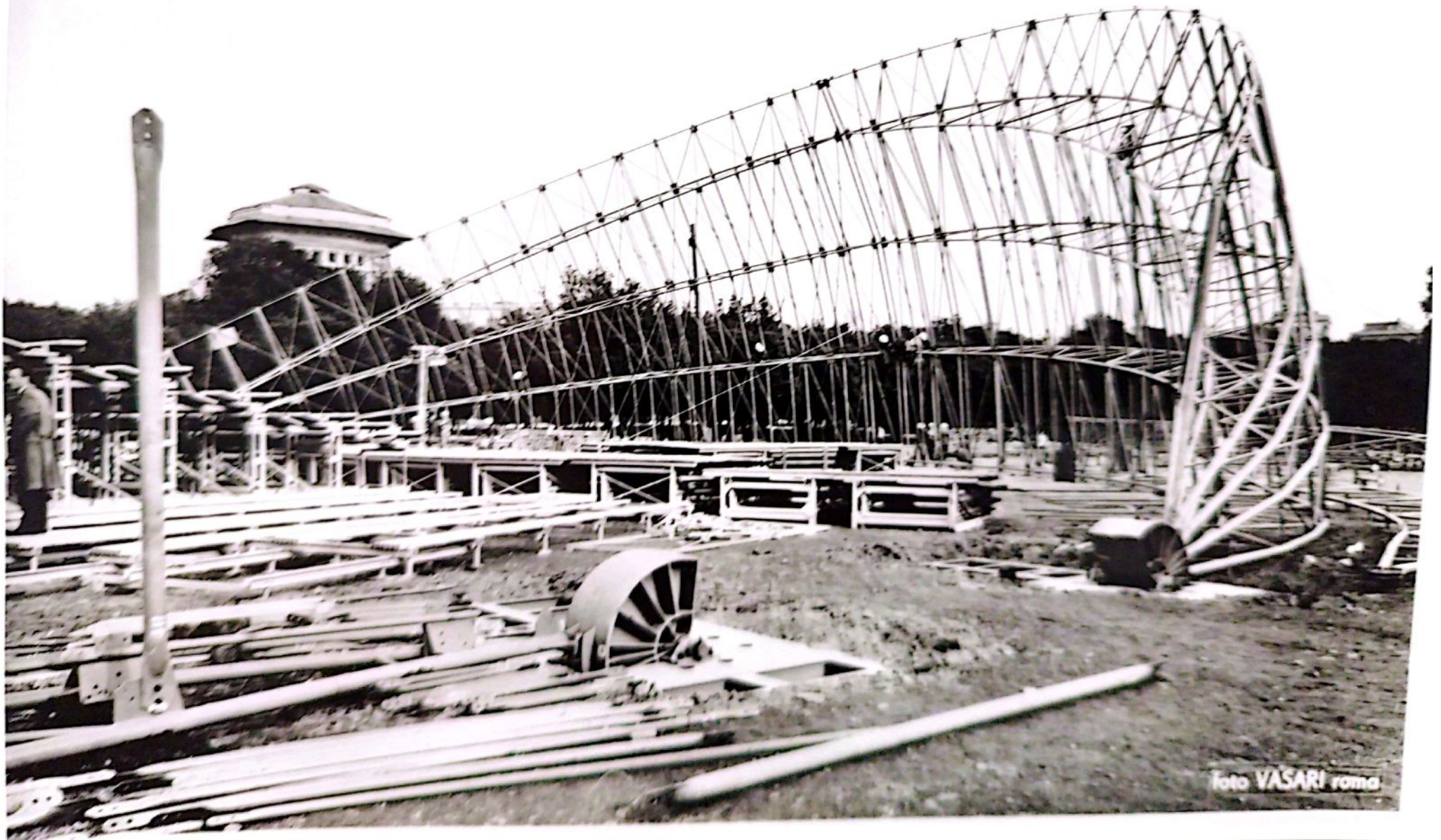

foto VASARI roma

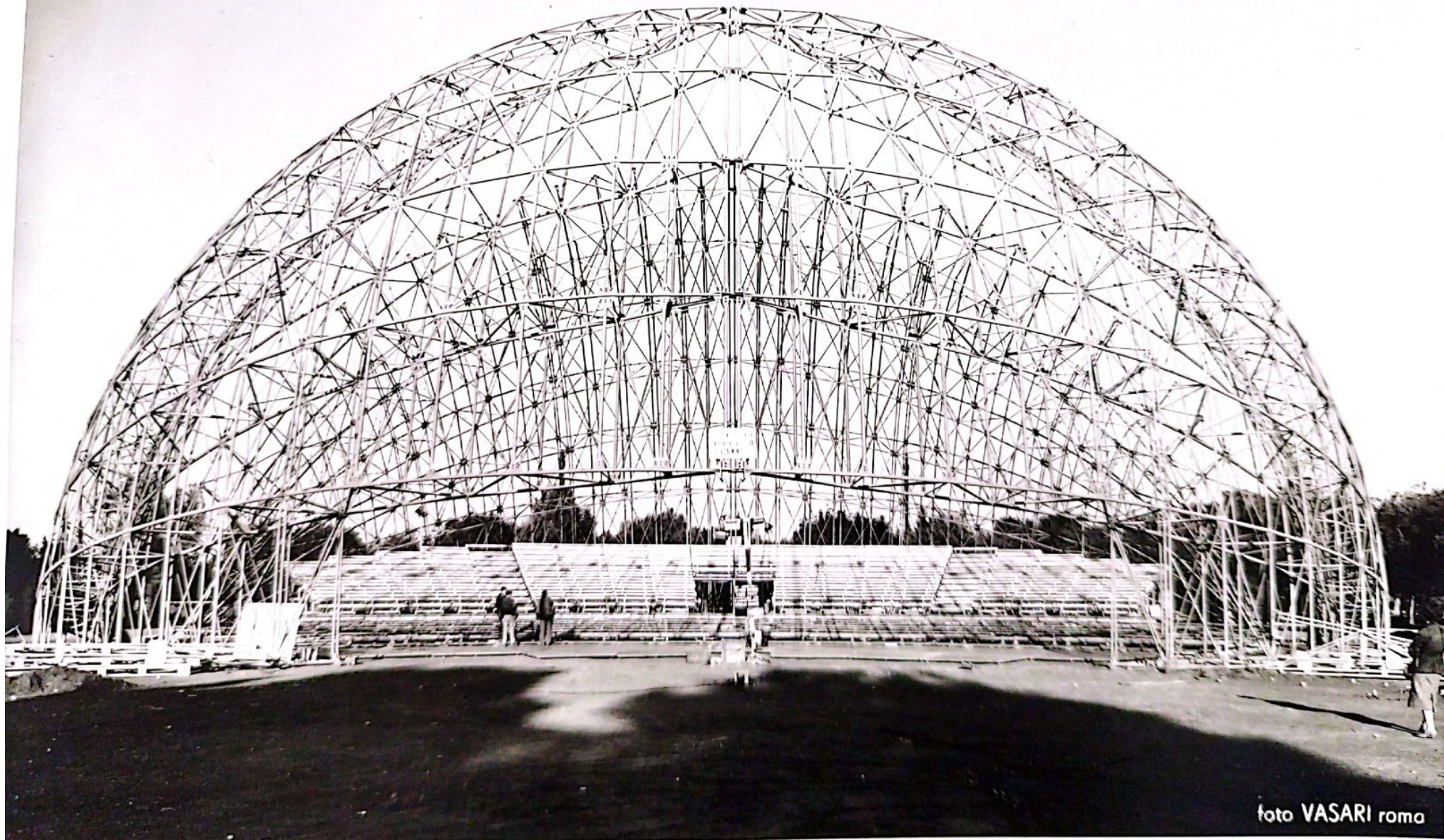

foto VASARI roma

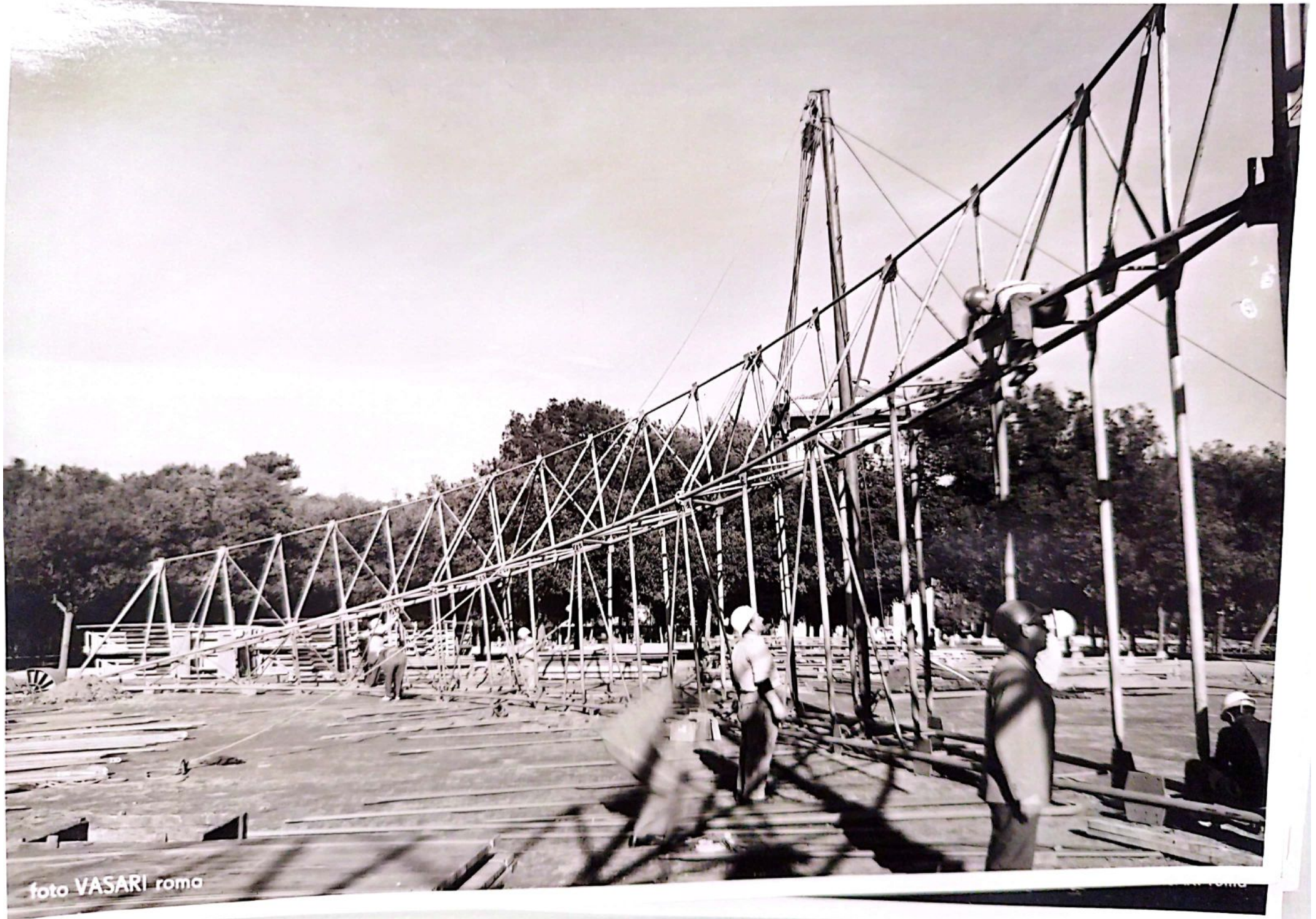

foto VASARI roma

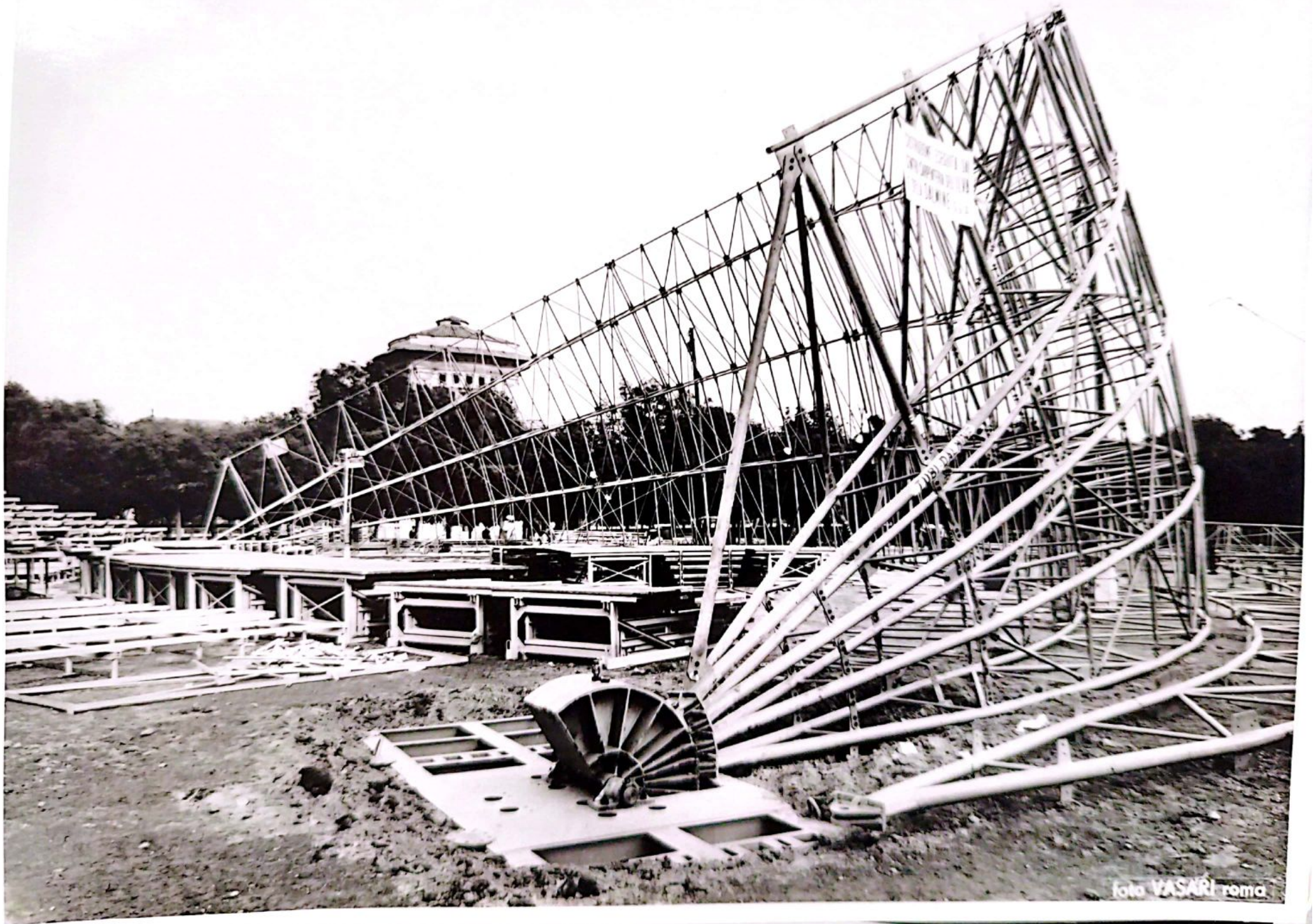

foto VASARI roma



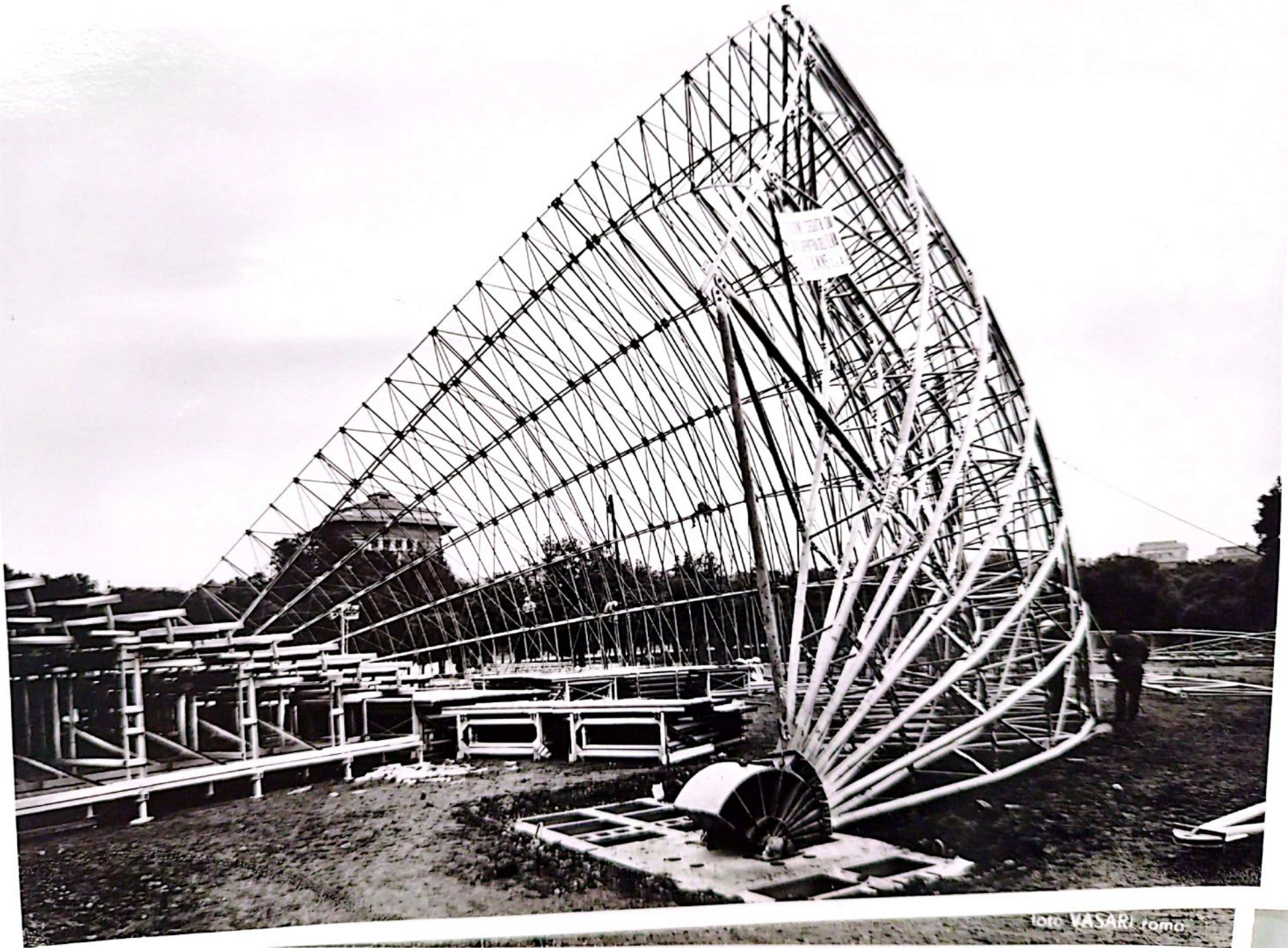

foto VASARI roma

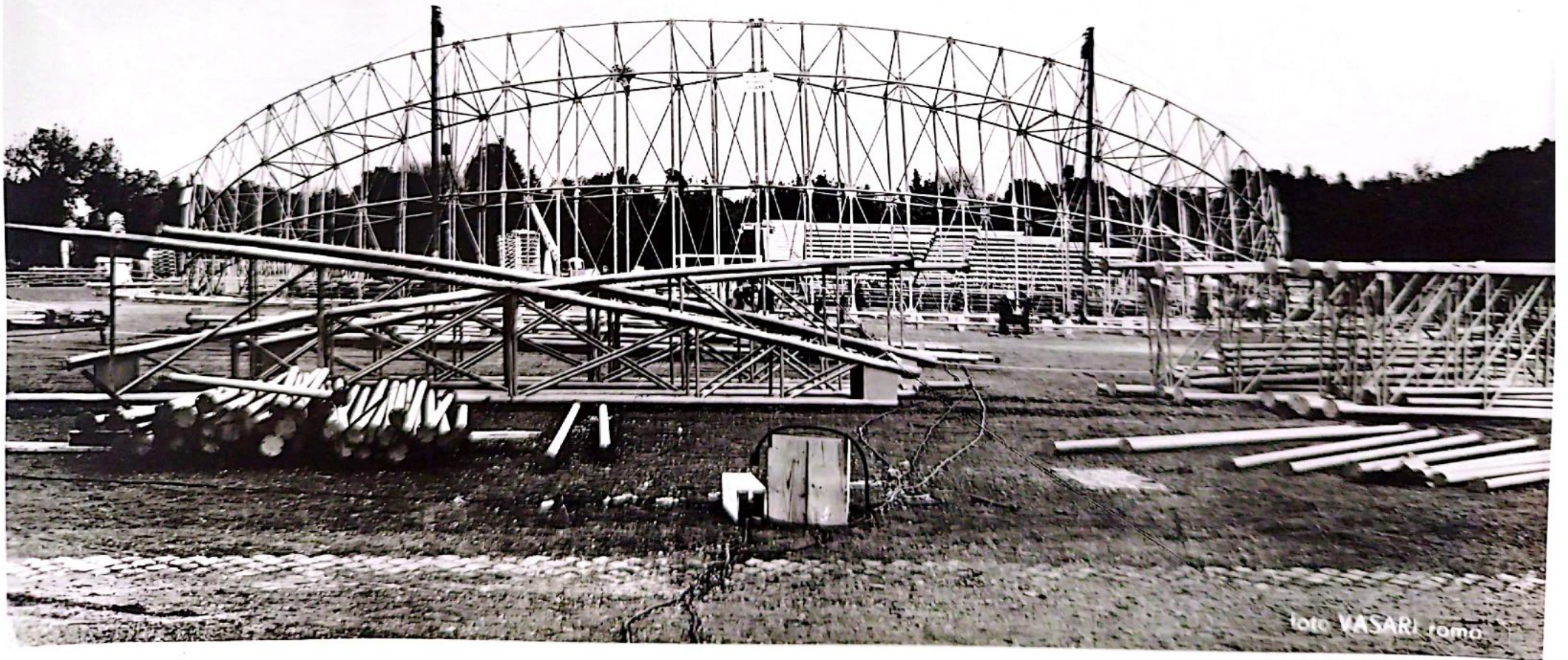

foto VASARI roma

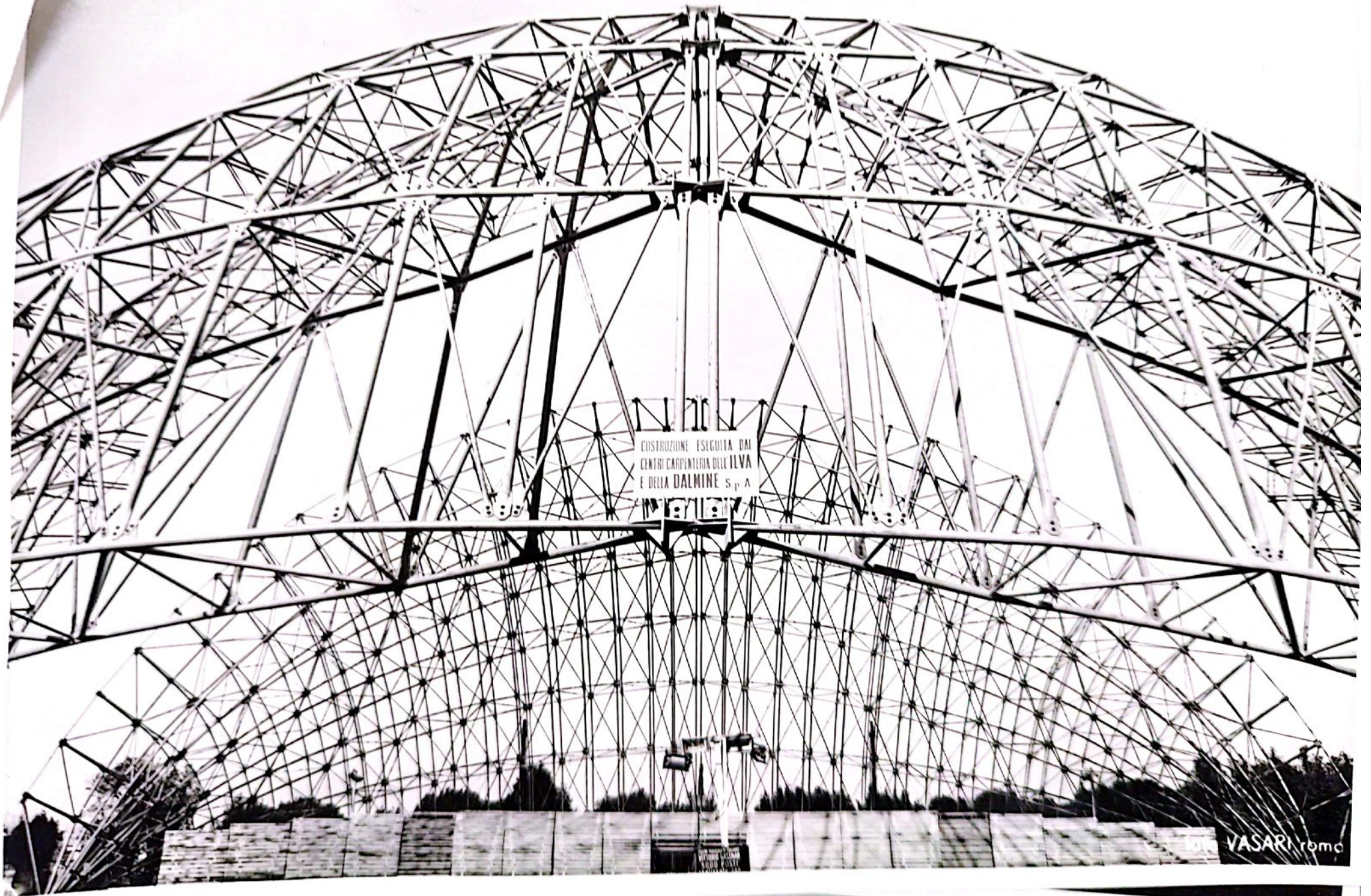

foto VASARI roma



foto VASARI roma

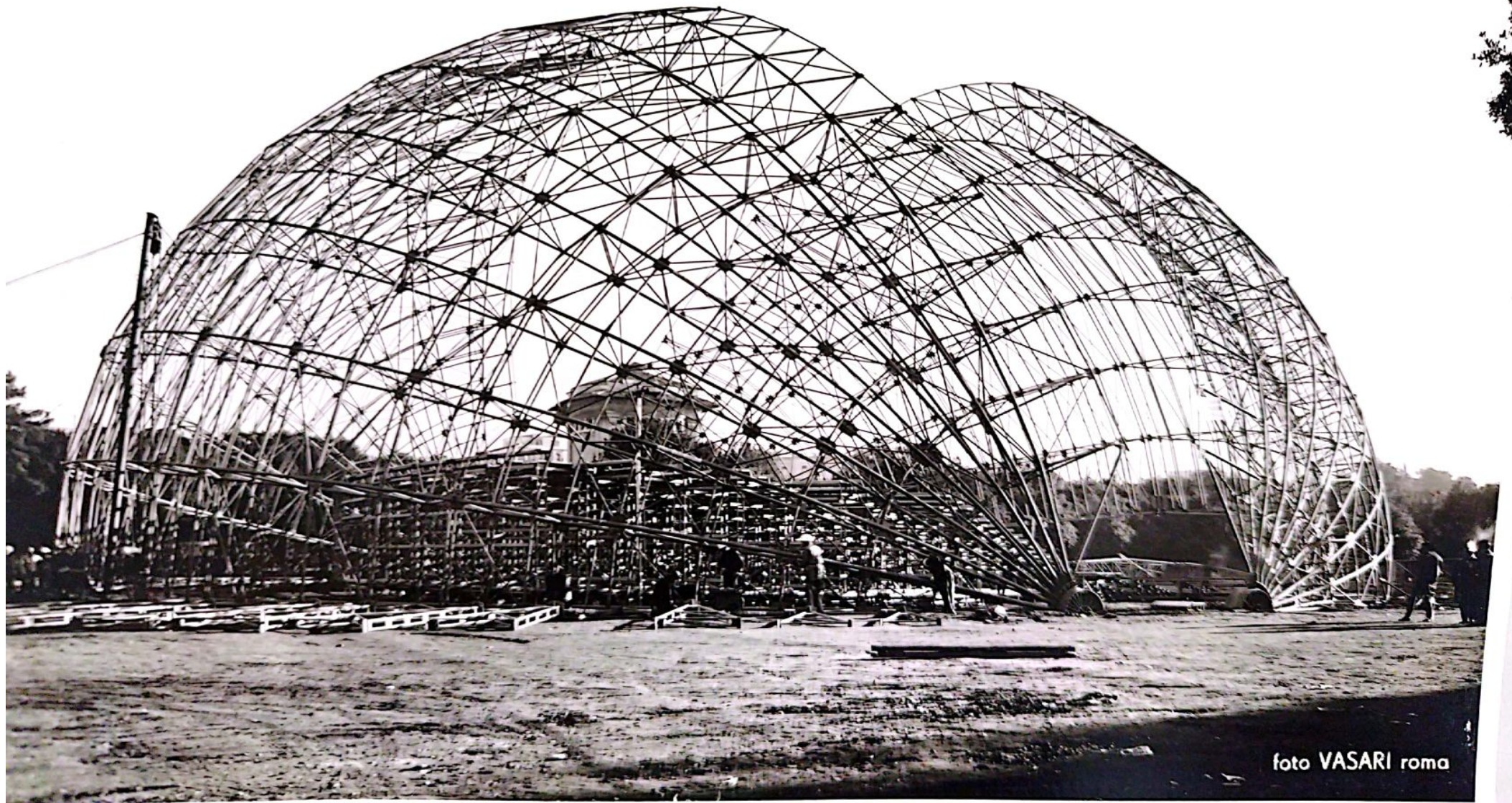

foto VASARI roma



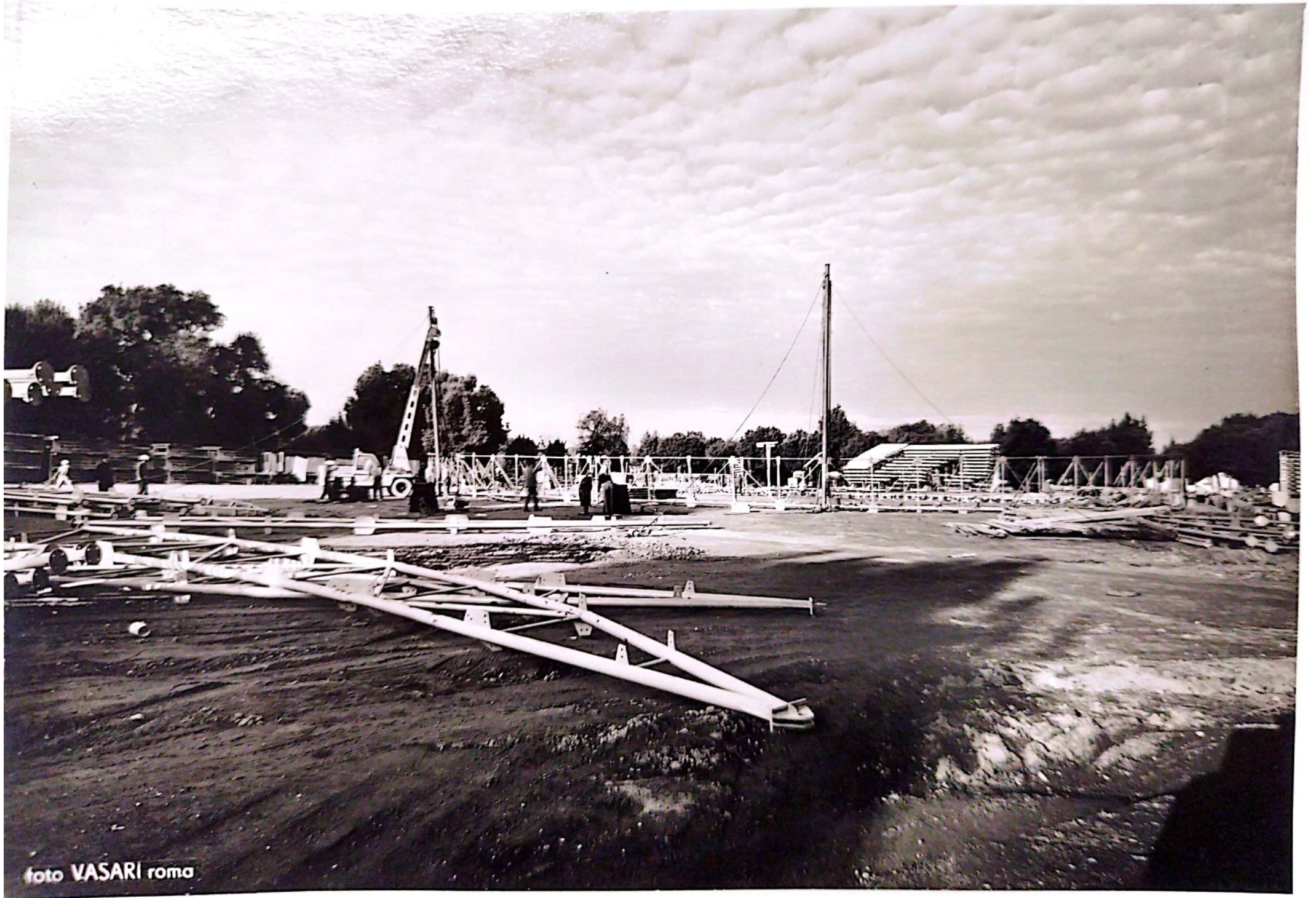

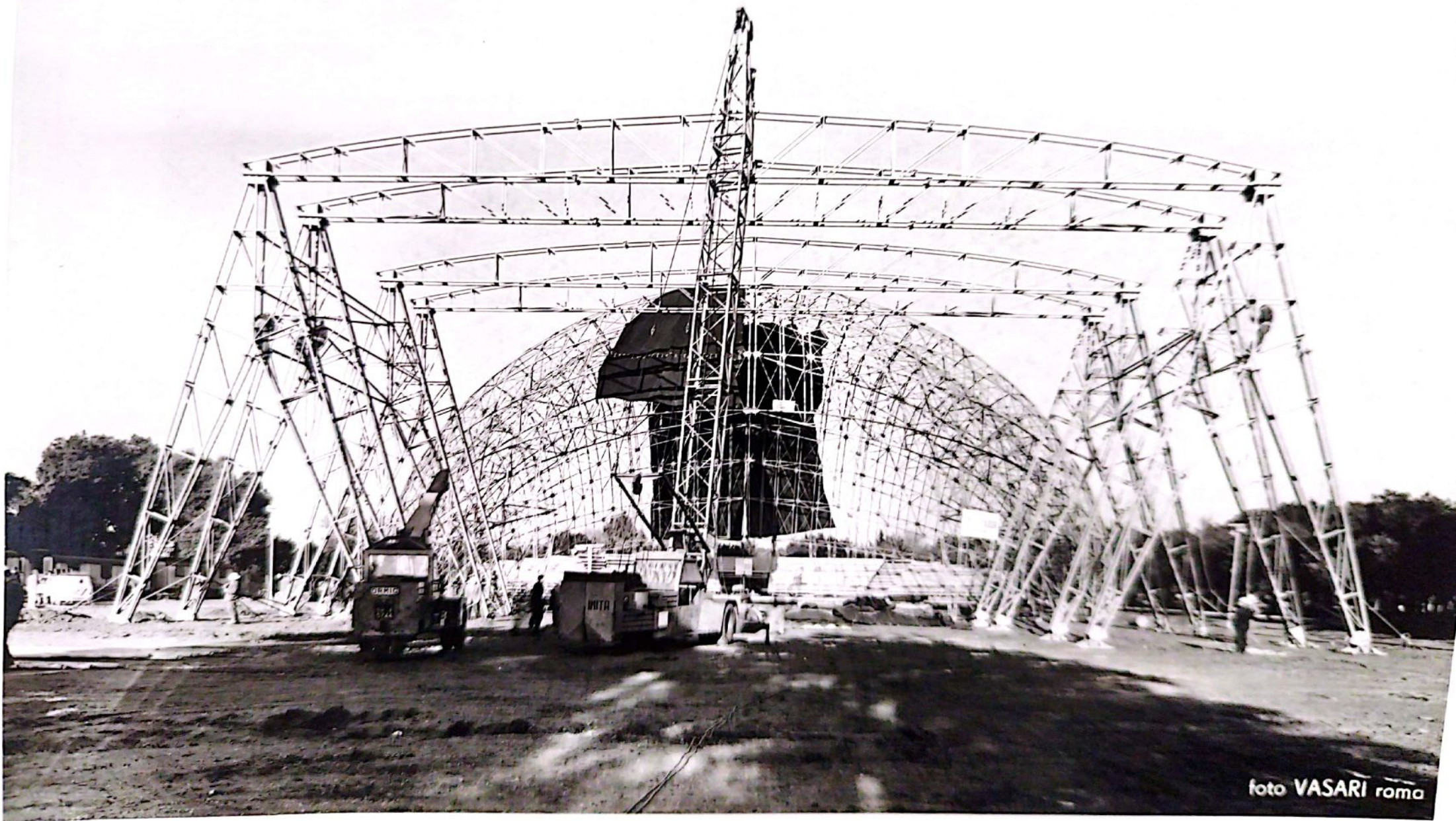
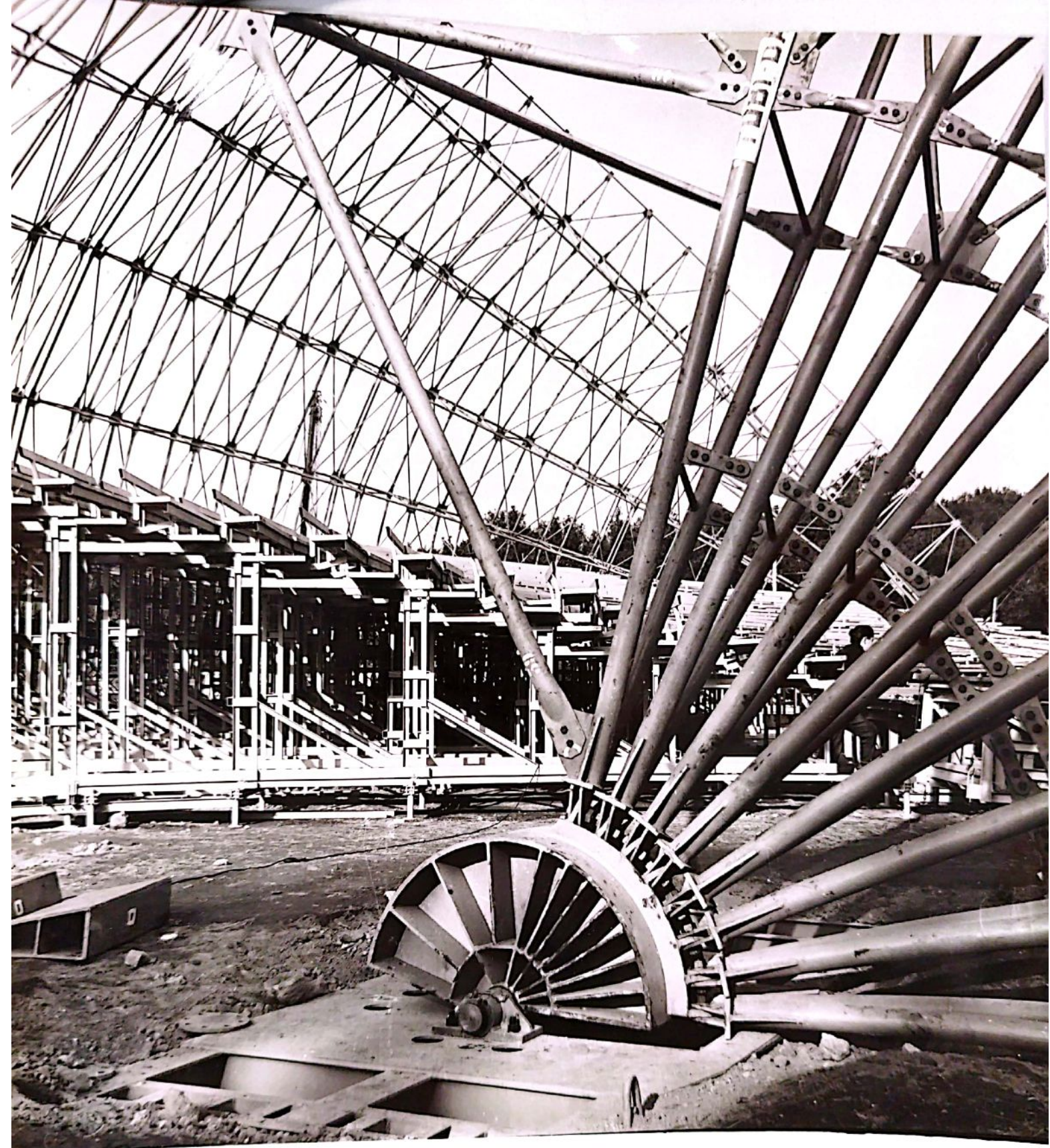
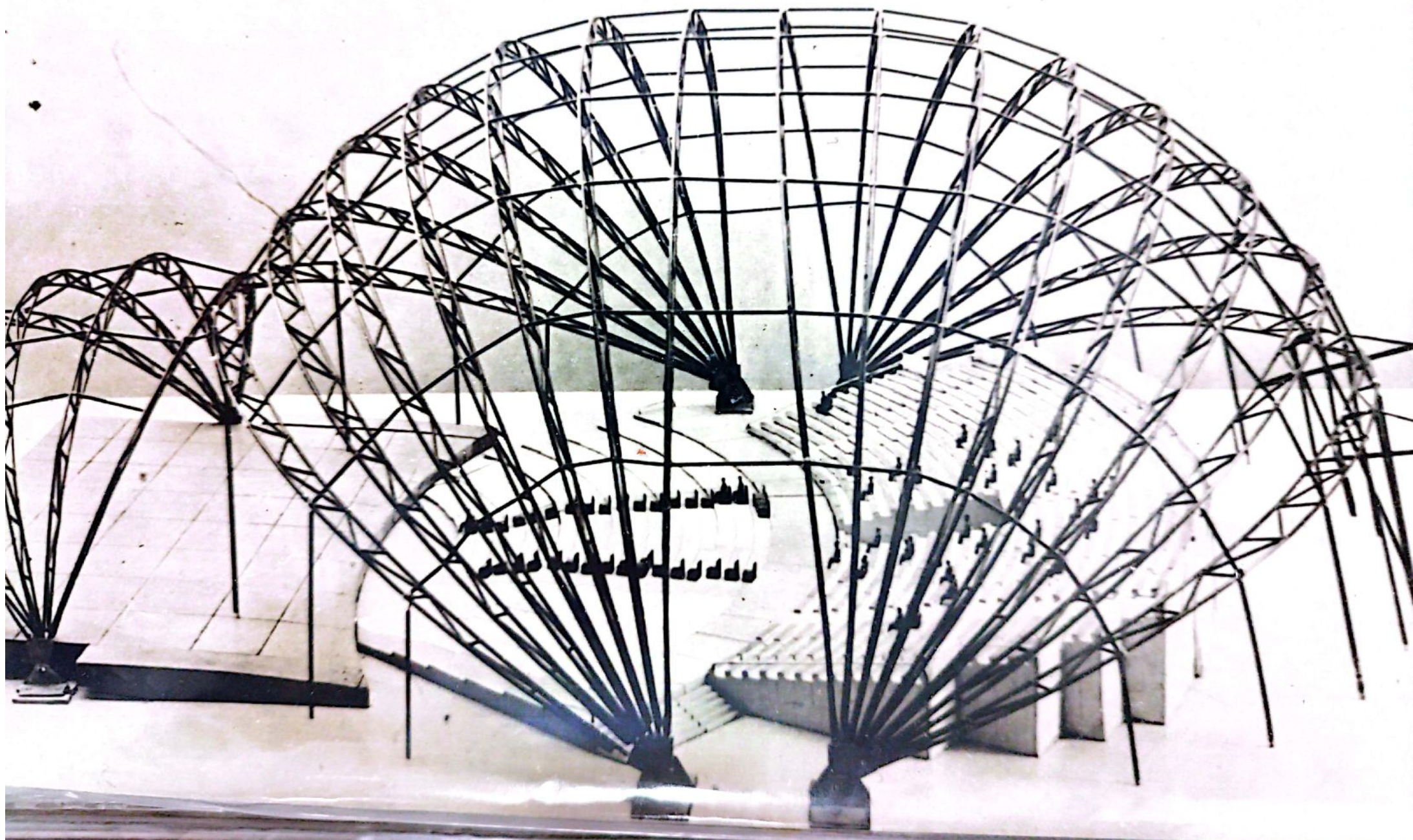

foto VASARI romc



foto VASARI rama

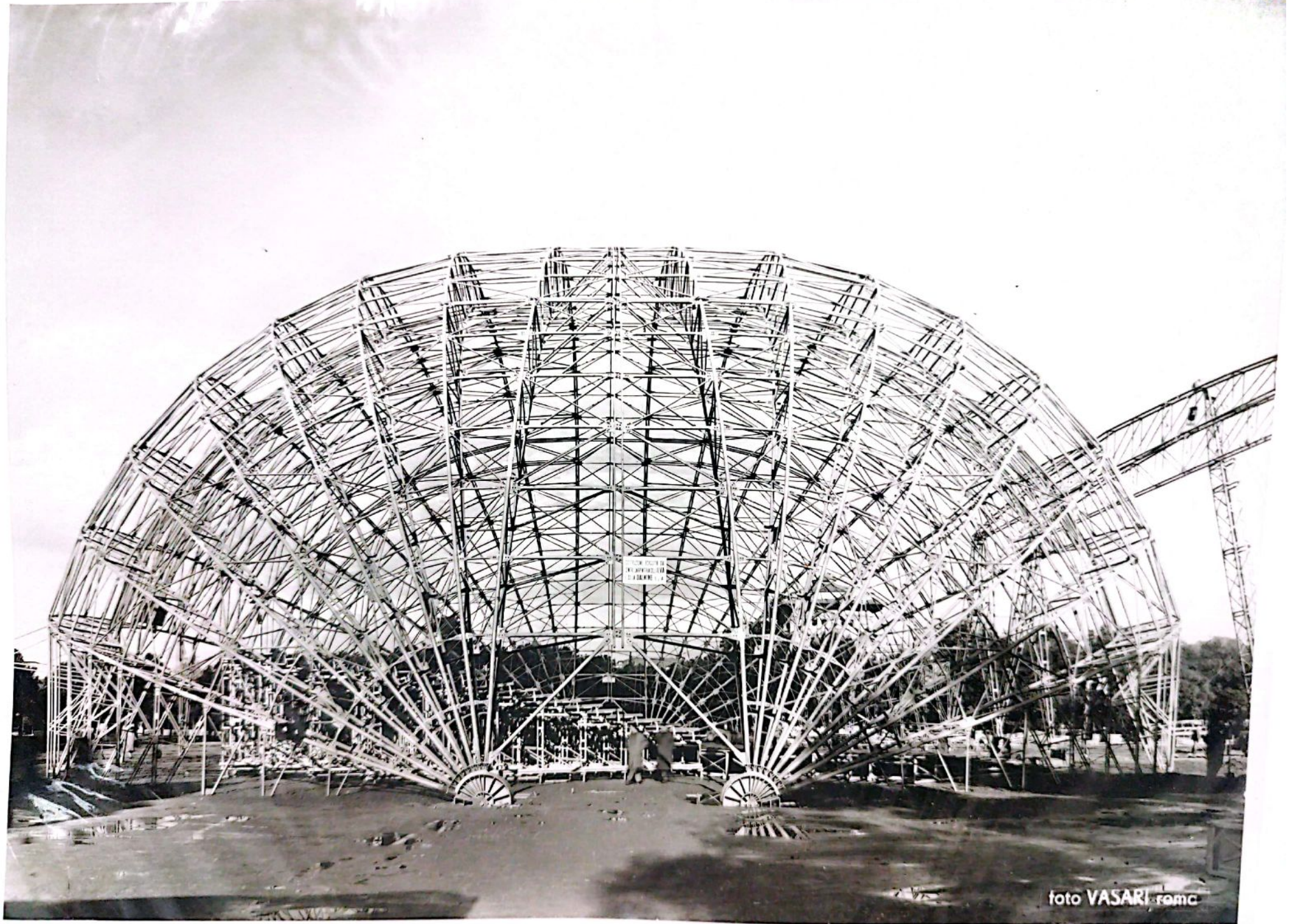

foto VASARI roma

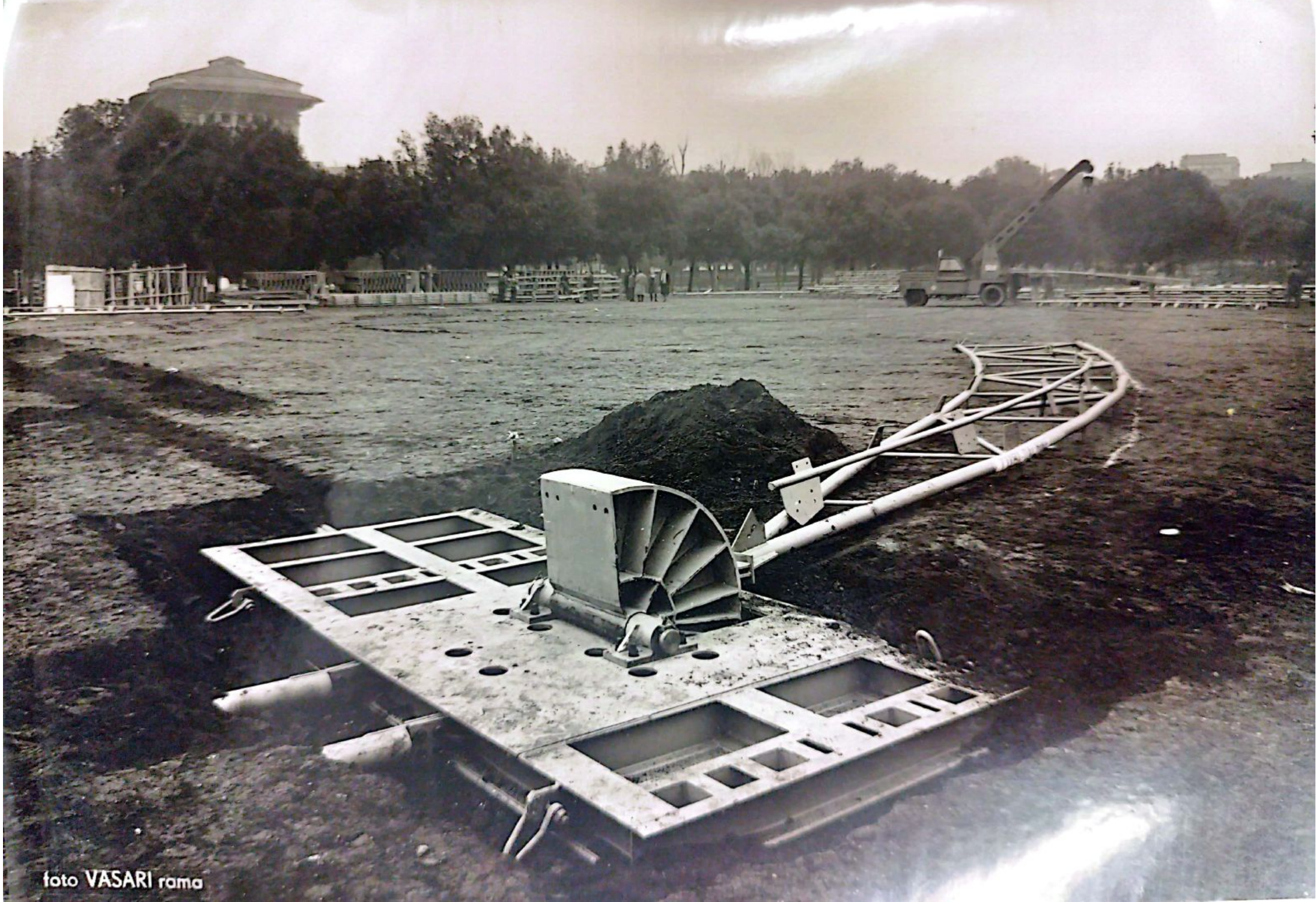

foto VASARI roma

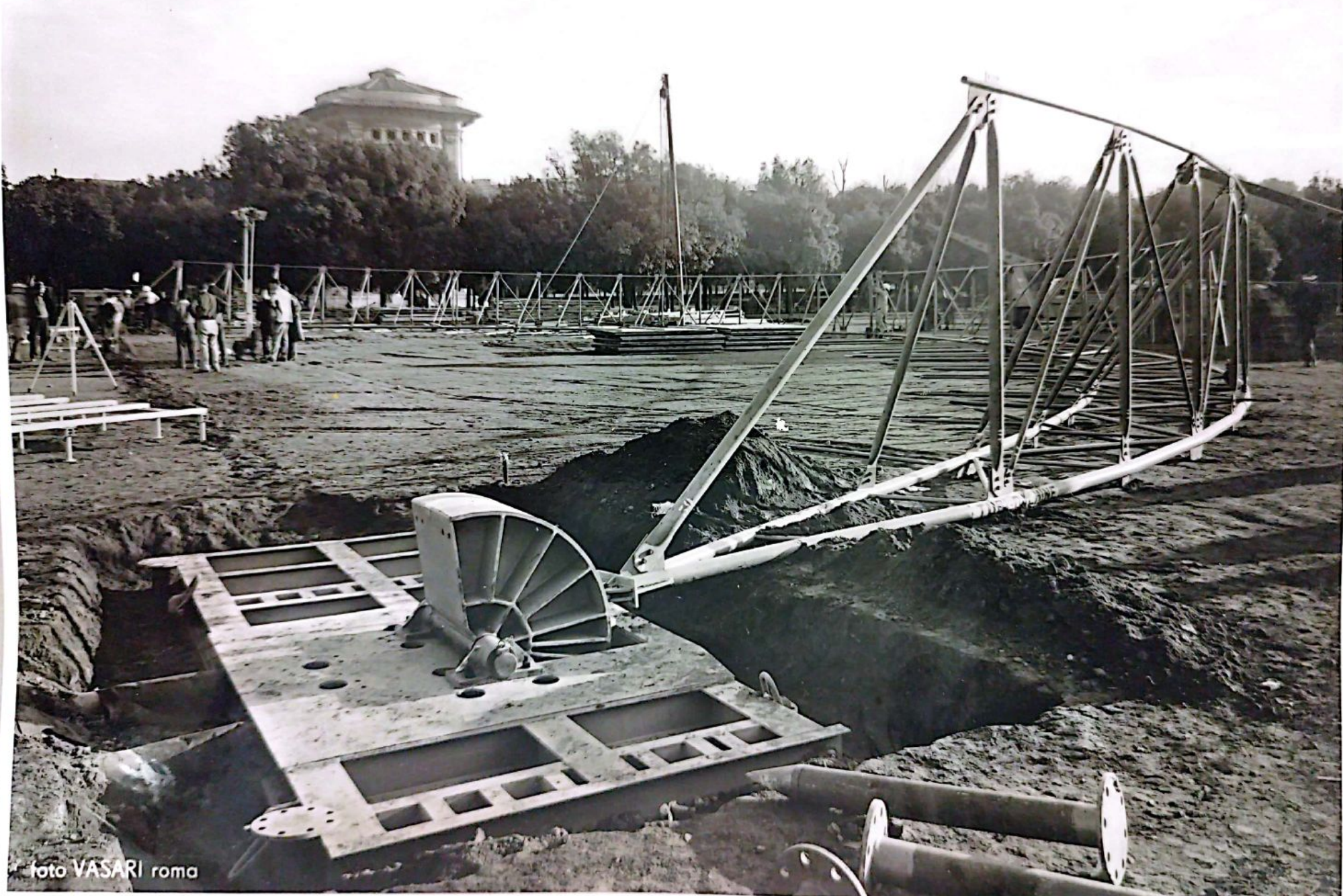

foto VASAKI roma



foto VASARI roma



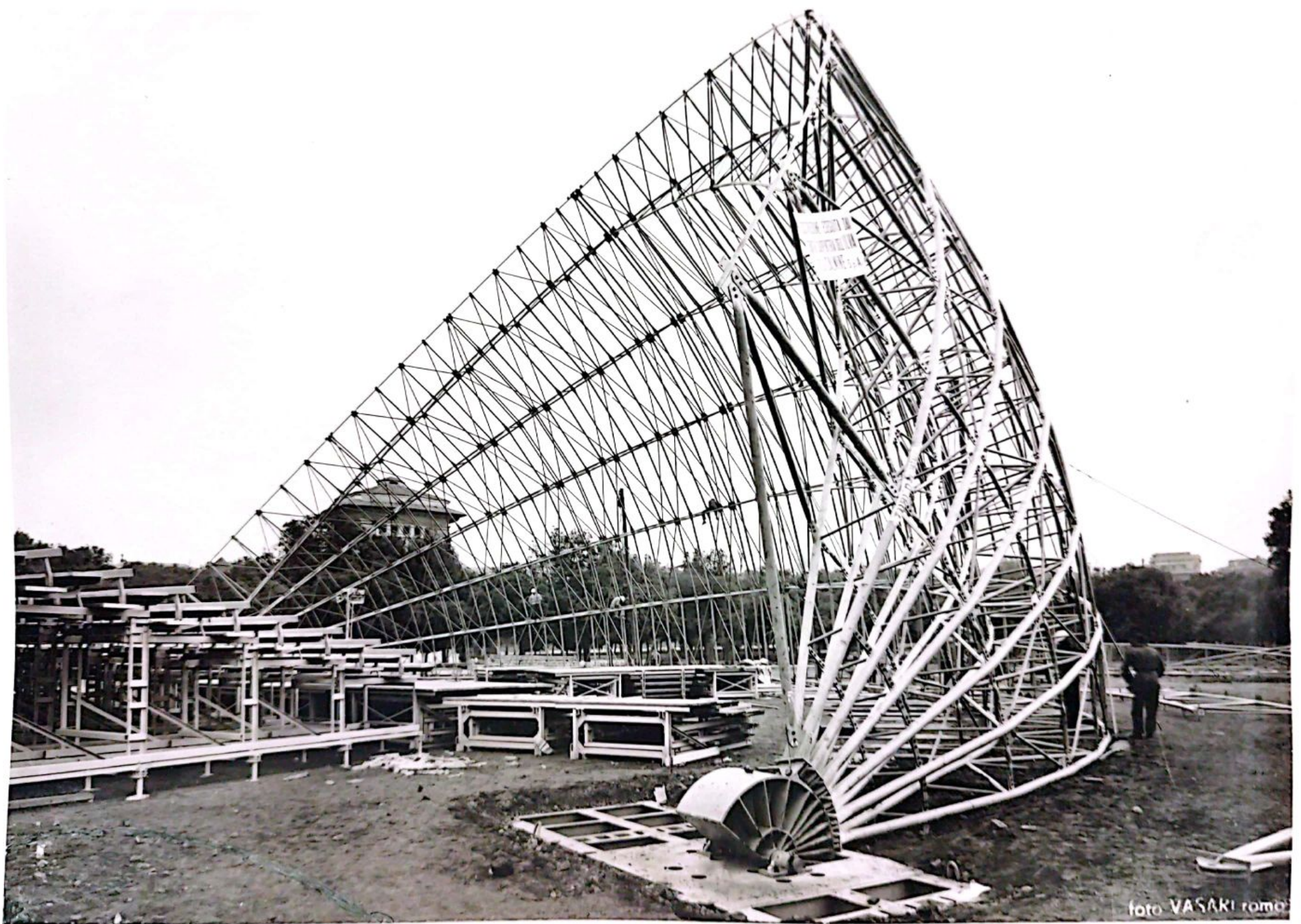

